

Accessories Catalog Heating solutions

For Cars, Trucks, Light-duty Vehicles, Special Vehicles, Rail and Recreational Vehicles

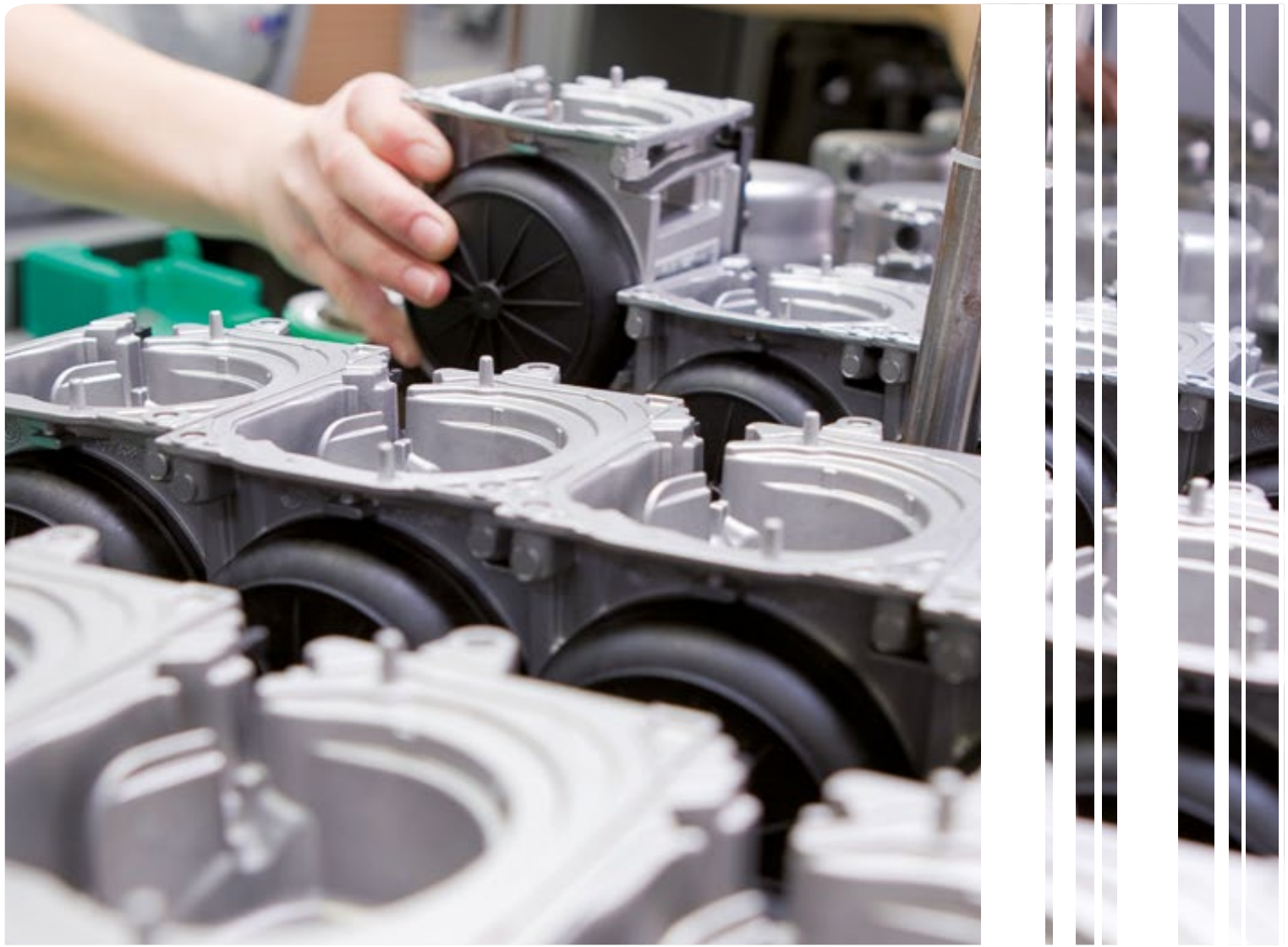

2018/2019



Dear Customers, dear Webasto Partners,

this Webasto catalog will give you an overview of the complete range of accessories for our current heating systems. On the following pages, you will find everything that you need for installing our heating systems, according to the type of vehicle, location and use. The mounting parts, test equipment and tools shown here are clearly laid out to enable you to find and order what you need quickly.

Together with the second accessory catalog for air-conditioning solutions and the product catalogue (showing the basic scope of delivery, installation kits and control units), this catalog will provide a comprehensive source of information so that you can work efficiently with our heating and cooling units.

**We wish you great success with our products,
Your Webasto Team**

Table of Contents

Combustion Air Line	8
Exhaust System	10
Fuel System	15
Hot Air System	27
Water System	37
Valve	44
Mounting Parts	47
Electrical Accessories	55
Maintenance and Diagnostics	70

Combustion Air
Line

Exhaust System

Fuel System

Hot Air System

Water System

Valve

Mounting Parts

Electrical
Accessories

Maintenance and
Diagnostics

Application of an air heating system

Webasto air heating systems can be ordered tailored to your needs. The standard components are combined into a basic scope of delivery and a specific installation kit. You may need additional application material, depending on the application requirements and the installation location. You can find these in our comprehensive accessories program.



Hot air intake system
Choose between fresh air and recirculating air mode, depending on the requirements or field of application.

Control element
Choose from our portfolio of different control elements, such as a simple rotary switch, the ThermoCall or a digital timer.



Electrical connection
A standardized wiring harness simplifies the connection of heater, control element and vehicle. It also offers a diagnostic possibility.

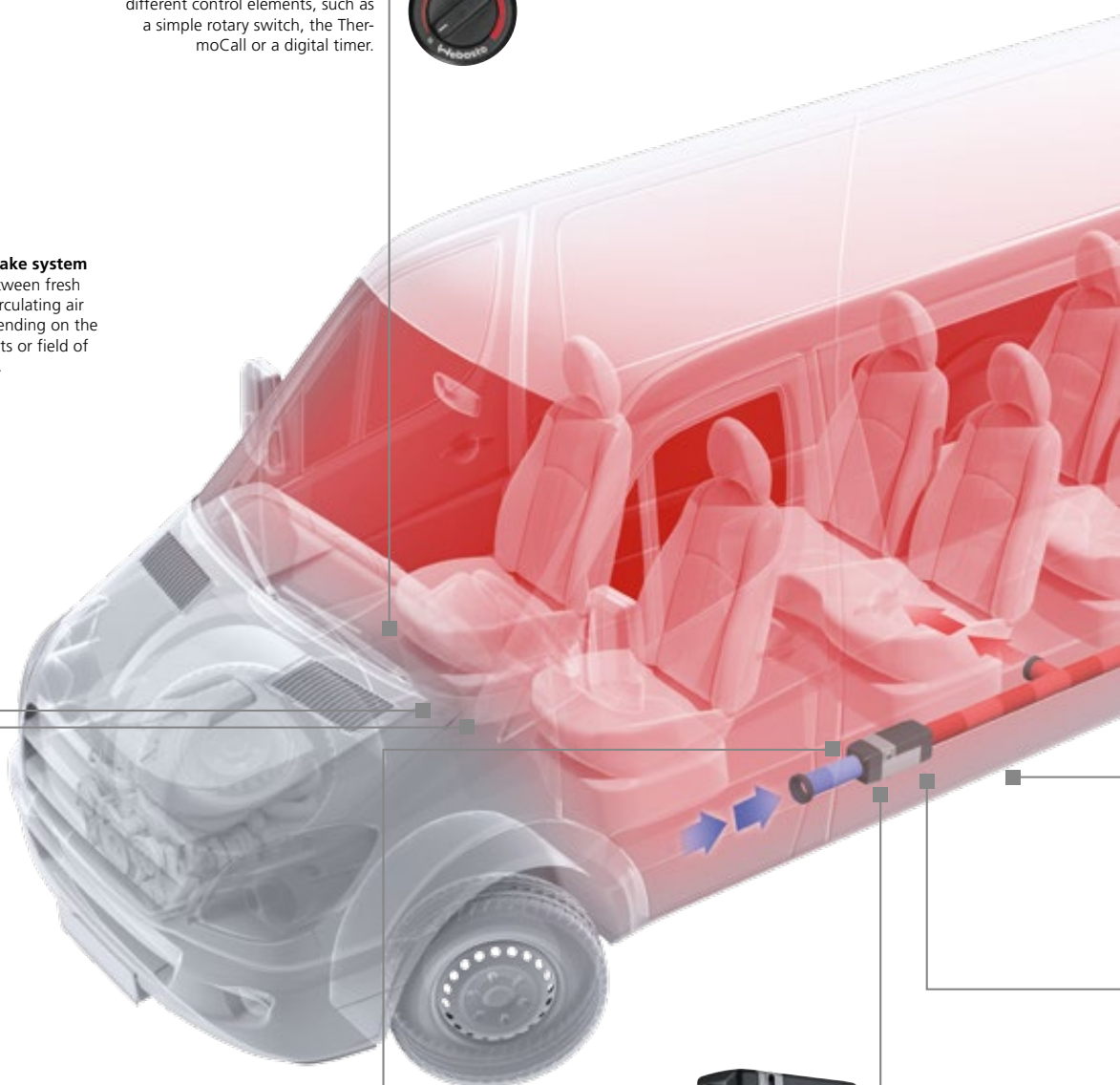

Exhaust system
The resulting exhaust gases has to be discharged via exhaust pipes.



Air heater
Air heaters are available with heating capacities from 2.0 to 5.5 kW.



Hot air distribution

Configure the air distribution system individually using additional hoses, distributors and air outlets to achieve optimum heat distribution in the vehicle.



Fuel supply

A connection has to be made to the fuel tank. A fuel pump is part of the basic delivery scope.



Combustion air intake

The required combustion air has to be drawn in selectively from a dry area.

Advantages of air heating systems

- Low investment and installation cost
- Easy integration in the vehicle
- Short heating times
- Individual configuration of the air distribution
- Recirculating air or fresh air mode

Application of a water heating system

Webasto water heating systems can be ordered tailored to your needs. The standard components are combined into a basic scope of delivery and a vehicle specific installation kit. You may need additional application material, depending on the application requirements and the installation location. You can find these in our comprehensive accessories program.



Control element

Choose from our portfolio of different control elements, such as a simple switch, the ThermoCall or a remote control.

Integration into the water circuit

Depending on the vehicle type, choose the required application material such as hoses, valves or thermostats from the standard installation kit or our accessories portfolio.



Electrical connection

A standardized wiring harness simplifies the connection of heater, control element and vehicle. It also offers a diagnosis interface.



Exhaust system

The resulting exhaust fumes have to be discharged via exhaust tube.

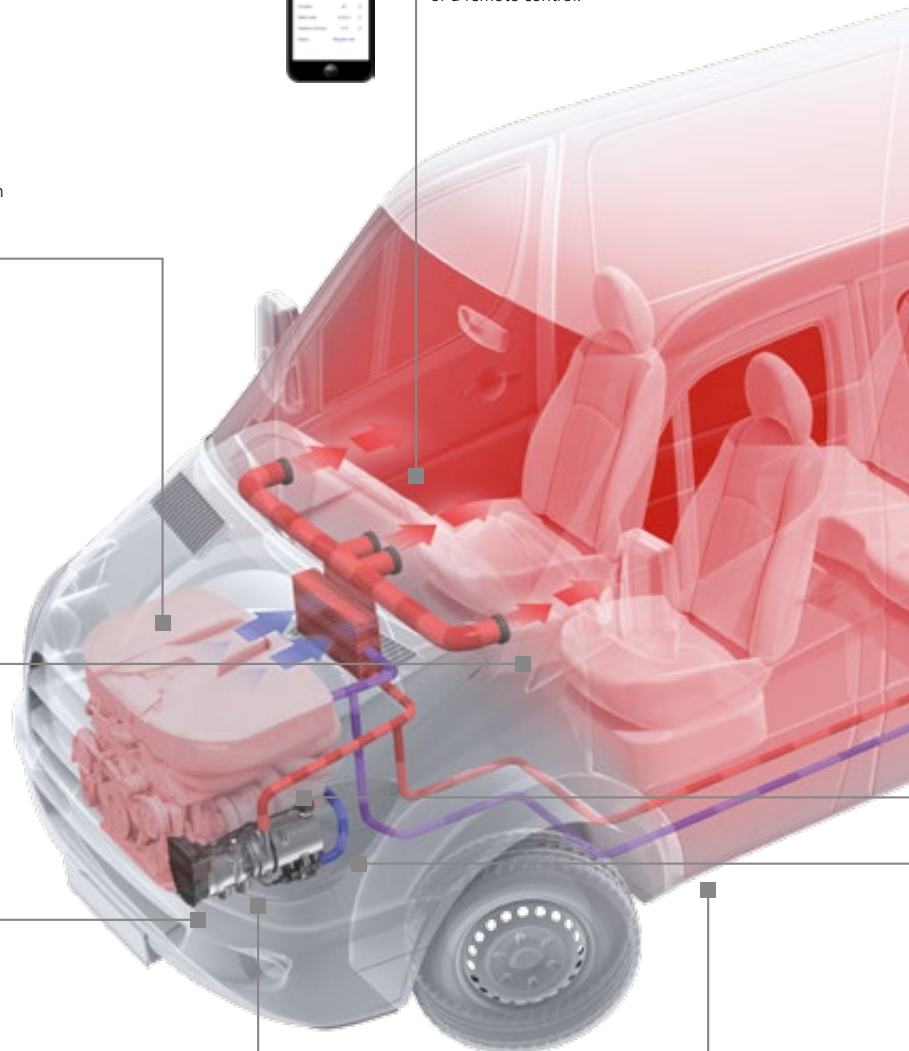

Water heater

Heaters are available with heating capacities from 2 to 40 kW.



Coolant pump

Choose the required coolant pump from the broad accessories portfolio. For the eThermo Top Eco, Thermo Top Evo 4/5/5+, Thermo Pro 50 Eco, Thermo Pro 90 and Thermo Top Pro 120/150 heaters, a standard pump is included in the basic scope of delivery.



Combustion air intake

The required combustion air is provided via a air inlet pipe.



Fuel supply

A fuel operated heater needs a fuel supply via a fuel pump which is part of the basic scope of delivery.



Advantages of water heating systems

- Engine preheating and/or cabin heating
- Longer life of the engine thanks to reduction of cold starts
- Full integration in the existing heating system of the vehicle with a maximum of comfort for the passengers
- Use of the vehicle engine heat to bridge short standstill times without using the heater to reduce fuel consumption and emissions



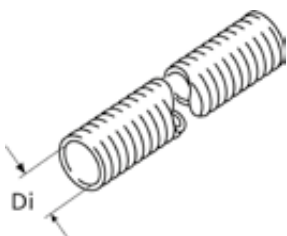

Combustion Air Line

		Air Top 2000 STC	Air Top Evo 40/55	Thermo Pro 90	Thermo Top Evo	Thermo Pro 50 Eco	Thermo Top C/E	Order number
	Intake muffler pipe							
	Di = 22 mm, L = 800 mm, PAK, without penetration protection cap	■						1322455A
	Di = 25 mm, L = 650 mm, AK / PAKL, AK / PAKL, with penetration protection cap		■					1319924A
	Di = 30 mm, L = 1160 mm, PAK / PAKL, without penetration protection cap			■				1319607A
	Intake muffler							
	Da = 21 mm, L = 97 mm, black, plastic, with mounting base and installation instructions	■			■	■	■	98141A
	Air intake silencer							
	Da = 24.2 mm, L = 138 mm, plastic, complete with 300 mm flexible pipe, D1a = 24 mm		■					9025956A
	Combustion air elbow							
	plastic							
	Di = 22 mm	■			■	■	■	1320144A
	Di = 25 mm		■					1320278A
	Flexible exhaust pipe							
	Di = 30 mm, Da = 34 mm, stainless steel							
	L = 3000 mm			■				1321494A
	L = 5000 mm			■				1321495A
	L = 10000 mm			■				1321496A
	L = 20000 mm			■				1321493A





Combustion Air Line

	Air Top 2000 STC	Air Top Evo 40/55	Thermo Pro 90	Thermo Top Evo	Thermo Pro 50 Eco	Thermo Top C/E	Order number	
	Flexible pipe							
	Di = 18 mm, L = 1000 mm, APGA-A						■	1319593A
	Di = 30 mm, L = 5000 mm, KAK						■	1321510A
	Di = 30 mm, L = 20000 mm, KAK						■	1321509A
	Di = 22 mm, L = 10000 mm, PAK						■	1321566A
	Di = 22 mm, L = 20000 mm, PAK						■	1321565A
	Di = 25 mm, L = 5000 mm, PAK						■	1321587A
	Di = 25 mm, L = 10000 mm, PAK						■	1321588A
	Di = 25 mm, L = 20000 mm, PAK						■	1321586A
	Di = 30 mm, L = 5000 mm, PAK						■	1321557A
	Di = 30 mm, L = 10000 mm, PAK						■	1321558A
	Di = 30 mm, L = 20000 mm, PAK						■	1321542A
	Protection cap							
	plastic							
	Di = 27 mm						■	1320257A
	Di = 36 mm						■	1321067A
Di = 39 mm						■	1320258A	

Exhaust System

		Air Top 2000 STC	Air Top Evo 40/55	Thermo Pro 50 Eco	Thermo Top C/E	Thermo Top Evo	Thermo 230/300/350	Thermo S 230/300/350/400	Thermo Pro 90	DBW 2010/2016	Thermo Top Pro 120/150	Order number
	Condensate drain L = 128 mm, copper, with mounting parts, for exhaust connecting pipe 1319935A	■	■	■	■							92621A
	End fixing kit					■						1317567A
	Exhaust deflector Di = 67 mm, Da = 86 mm, H = 62 mm						■	■				1320436A
	Hot air elbow Di = 71 mm, Da = 67 mm, L = 170 mm, W = 85 mm, painted, 90°						■	■				1319441A
	Exhaust elbow Di = 24 mm, Da = 24 mm, L = 110 mm, stainless steel, without condensate drain		■									1320383A





Exhaust System

		Air Top 2000 STC	Air Top Evo 40/55	Thermo Pro 50 Eco	Thermo Top C/E	Thermo Top Evo	Thermo 230/300/350	Thermo S 230/300/350/400	Thermo Pro 90	DBW 2010/2016	Thermo Top Pro 120/150	Order number
	Exhaust elbow Di = 22 mm, Da = 22 mm, L = 65 mm, aluminium, without condensate drain	■										1320117A
	Exhaust elbow Di = 24 mm, Da = 24 mm, L = 110 mm, stainless steel, with condensate drain		■									1320378A
	Exhaust muffler Da = 22 mm, L = 179 mm, W = 45 mm, stainless steel	■		■	■	■						1320910A
	Exhaust muffler L = 170 mm, W = 85 mm, H = 45 mm Da = 22 mm, stainless steel	■		■	■	■						1320895A
	Da = 22 mm, steel, zinc powder paint surface protection for temperatures up to 650 °C	■		■	■	■						1320841A
	Da = 24 mm, steel, zinc powder paint surface protection for temperatures up to 650 °C		■									1320372A
	Exhaust muffler Da = 38 mm, L = 206 mm, W = 57 mm, steel, surface protection zinc powder paint for temperatures up to 600 °C							■	■			1320840A



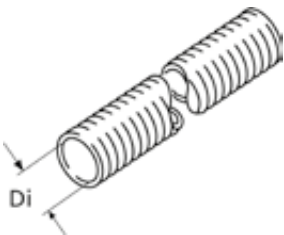

Exhaust System

		Air Top 2000 STC	Air Top Evo 40/55	Thermo Pro 50 Eco	Thermo Top C/E	Thermo Top Evo	Thermo 230/300/350	Thermo S 230/300/350/400	Thermo Pro 90	DBW 2010/2016	Thermo Top Pro 120/150	Order number
	Exhaust muffler Da = 38 mm, L = 270 mm, W = 130 mm, stainless steel	■		■	■	■				■		1321397A
	Exhaust muffler Di = 38 mm, L = 1000 mm, Outside with partial fiberglass insulation									■		1321823A
	Exhaust pipe reducer sleeve Di = 22 mm, Da = 24 mm, L = 40 mm, stainless steel		■									1320382A
	Flexible heat protection pipe L = 10000 mm Di = 28 mm, GA-A (aluminium foil and aluminium coated glass fabric) Di = 45 mm, GA2-A (aluminium and aluminium coated glass fabric)	■		■	■	■						1321601A
		■	■	■	■	■		■	■			1321602C





Exhaust System

	Air Top 2000 STC	Air Top Evo 40/55	Thermo Pro 50 Eco	Thermo Top C/E	Thermo Top Evo	Thermo 230/300/350	Thermo S 230/300/350/400	Thermo Pro 90	DBW 2010/2016	Thermo Top Pro 120/150	Order number
 <p>Flexible pipe</p>											
Di = 22 mm, Da = 26 mm, L = 1000 mm, stainless steel, with end cap	■		■	■	■						1322414A
Di = 24 mm, Da = 28 mm, L = 10000 mm, stainless steel		■									1321523A
Di = 38 mm, Da = 41 mm, L = 1000 mm, stainless steel, with end cap										■	1322674A
Di = 38 mm, Da = 41 mm, L = 5000 mm, stainless steel								■	■		1321540A
Di = 38 mm, Da = 41 mm, L = 10000 mm, stainless steel								■	■		1321541A
Di = 38 mm, Da = 41 mm, L = 20000 mm, stainless steel								■	■		1321539A
Di = 70 mm, Da = 73.6 mm, L = 10000 mm, stainless steel						■	■				1321567A
Di = 70 mm, Da = 70 mm, L = 5000 mm, stainless steel						■	■				1321568A
 <p>Insulating sleeve</p>											
L = 120 mm, W = 108 mm, glass fabric, for exhaust mufflers 1320841A and 1320895A	■	■	■	■	■						1320848A
 <p>Insulating tape</p>											
L = 50000 mm, W = 60 mm, white, E-glass, usage temperature 450 °C, 550 °C for short periods, 2 mm thick	■	■	■	■				■	■		1320357A
 <p>Flexible heat protection pipe</p>											
Di = 28 mm, Da = 38 mm, L = 324 mm, with cover, non-flammable, interior resistant to temperatures up to 500 °C	■		■	■	■						1319670A



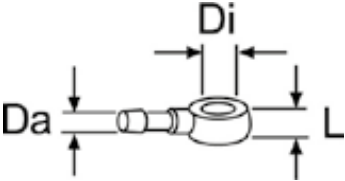

Exhaust System

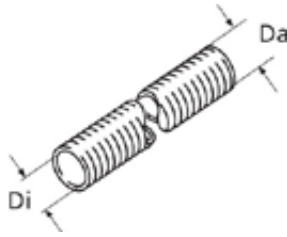
		Air Top 2000 STC	Air Top Evo 40/55	Thermo Pro 50 Eco	Thermo Top C/E	Thermo Top Evo	Thermo 230/300/350	Thermo S 230/300/350/400	Thermo Pro 90	DBW 2010/2016	Thermo Top Pro 120/150	Order number
	Protection cap											
	L = 17 mm, stainless steel, for flexible exhaust pipe											
	Di = 26 mm	■		■	■	■						1320109A
	Di = 28 mm		■									1320217A
	Di = 42 mm							■	■			1321753A
	Heat protection hose											
	Di = 70 mm, Da = 120 mm, L = 1850 mm, fiberglass	■	■	■	■	■			■	■		1320830A
	Spacer											
	Di = 25 mm, Da = 48 mm, W = 21 mm, for flexible pipe	■		■	■	■						1317843A
	Exhaust connecting pipe											
	Da = 24 mm, L = 65 mm, steel, with anti-corrosion protection and condensate drain		■									1319935A
	Da = 24 mm, L = 50 mm, stainless steel, without condensate drain		■									1319937A
	Da = 38 mm, L = 65 mm, stainless steel, with condensate drain, for exhaust mufflers 1320841A and 1320895A							■				1320959A
	Exhaust mounting kit											
	with pipe clamp and 2 brackets										■	9035487A

Fuel System

		DBW 2010/2016	Thermo 230/300/350	Thermo S 230/300/350/400	Air Top 2000 STC	Air Top Evo 40/55	Thermo Top Evo	Thermo Pro 50 Eco	Thermo Top C/E	Thermo Pro 90	Thermo Top Pro 120/150	Order number
	Banjo											
	L = 10 mm, steel zinc coated											
	Di = 10 mm, Da = 5 mm	■	■	■								1320747A
	Di = 10 mm, Da = 6 mm	■	■	■								1321062A
	Di = 12 mm, Da = 6 mm	■	■	■								1319355A
	Banjo bolt											
	L = 25 mm, steel zinc coated, M10 x 1 connection thread	■	■	■								1320999A
	Connecting pipe											
	Da = 8 mm, L = 56 mm, plastic, VOME-resistant, bag of 10 pieces	■	■	■								1321079A
	Mini Jacket fuel pump protector											
	Protection device for fuel pumps with mufflers, required by ISO 7840 if the fuel system is installed in engine rooms				■	■	■	■	■	■		1319522A
	Flexible heat protection pipe											
	GA-A (aluminium foil and aluminium coated glass fabric)											
	Di = 14.5 mm, Da = 16.5 mm, L = 20000 mm				■	■	■	■	■	■		1321584B
	Di = 14.5 mm, Da = 16.5 mm, L = 5000 mm				■	■	■	■	■	■		1321585B
	Di = 28 mm, Da = 31 mm, L = 2000 mm				■	■	■	■	■	■		1322650A
	Di = 28 mm, Da = 31 mm, L = 20000 mm				■	■	■	■	■			1317127A



Fuel System

		DBW 2010/2016	Thermo 230/300/350	Thermo S 230/300/350/400	Air Top 2000 STC	Air Top Evo 40/55	Thermo Top Evo	Thermo Pro 50 Eco	Thermo Top C/E	Thermo Pro 90	Thermo Top Pro 120/150	Order number
	Fuel extractor, T-piece											
	L = 50 mm, copper											
	H = 26 mm, 6 x 5 x 6				■	■	■	■	■	■		1319300A
	H = 28 mm, 8 x 5 x 8				■	■	■	■	■	■		1319301A
	Fuel extractor, T-piece											
	L = 50 mm, plastic											
	H = 36 mm, 6 x 5 x 6				■	■	■	■	■	■		1321002A
	H = 38 mm, 8 x 5 x 8				■	■	■	■	■	■		1320192A
	H = 39 mm, 10 x 5 x 10				■	■	■	■	■	■		1321003A
H = 40 mm, 12 x 5 x 12				■	■	■	■	■	■		1319951A	
	H-shaped fuel extractor											
	L = 50 mm, steel zinc coated, Extraction at 90° elbow											
	H = 28 mm, 6 x 5 x 6				■	■	■	■	■	■		1319520A
	H = 28 mm, 8 x 5 x 8				■	■	■	■	■	■		1320574A
	H = 28 mm, 10 x 5 x 10				■	■	■	■	■	■		1320806A
H = 39 mm, 12 x 5 x 12				■	■	■	■	■	■		1321776A	
	Fuel extractor, T-piece											
	L = 50 mm, steel zinc coated											
	H = 33 mm, 5 x 5 x 5				■	■	■	■	■	■		1321996A
	H = 35 mm, 8 x 5 x 8				■	■	■	■	■	■		1320573A
	H = 36 mm, 6 x 5 x 6				■	■	■	■	■	■		1320572A
	H = 37 mm, 10 x 5 x 10				■	■	■	■	■	■		1320804A
H = 37 mm, 12 x 5 x 12				■	■	■	■	■	■		1320805A	
	Fuel extractor, T-piece											
	steel zinc coated, 15 x 6 x 15				■	■	■	■	■	■		1320577A



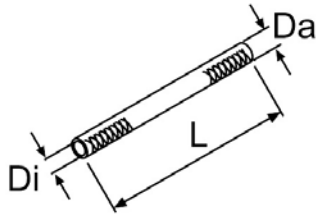
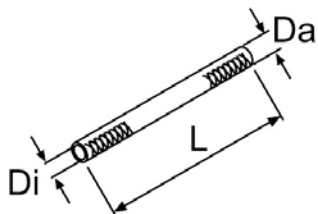

Fuel System

		DBW 2010/2016	Thermo 230/300/350	Thermo S 230/300/350/400	Air Top 2000 STC	Air Top Evo 40/55	Thermo Top Evo	Thermo Pro 50 Eco	Thermo Top C/E	Thermo Pro 90	Thermo Top Pro 120/150	Order number
	KKC84/1 holder with heater											
	For interchangeable filters	■										1320016A
	KKC85/1 holder											
	For interchangeable filters	■	■	■								1319823A
	Holder with housing for interchangeable filter											
	L = 135 mm, H = 80 mm, light metal, M14 x 1.5 connection thread	■	■	■								1319291A
	Interchangeable filter											
	For holder 1319291A	■	■	■								1320031A
	Fuel filter kit											
	Da = 5 mm, L = 60 mm, plastic transparent, with hose clips and connecting hoses				■	■	■	■	■	■		1319466A

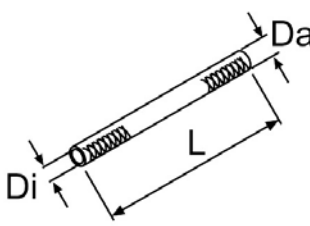

Fuel System

		DBW 2010/2016	Thermo 230/300/350	Thermo S 230/300/350/400	Air Top 2000 STC	Air Top Evo 40/55	Thermo Top Evo	Thermo Pro 50 Eco	Thermo Top C/E	Thermo Pro 90	Thermo Top Pro 120/150	Order number
	Fuel hose for boats											
	Di = 5 mm, Da = 15 mm, L = 50 mm				■	■	■	■	■	■		1320857A
	Fuel hose kit											
	Di = 4.5 mm, Da = 10 mm, L = 50 mm, VOME-resistant				■	■	■	■	■	■		1322837A
	Fuel hose											
	Di = 4.5 mm, Da = 9 mm, L = 5000 mm	■	■	■	■	■	■	■	■	■		1321500A
	Di = 4.5 mm, Da = 9 mm, L = 10000 mm	■	■	■	■	■	■	■	■	■		1321502A
	Di = 5 mm, Da = 10 mm, L = 5000 mm	■			■	■	■	■	■	■		1321559A
	Di = 5 mm, Da = 10 mm, L = 10000 mm	■			■	■	■	■	■	■		1321560A
	Di = 6 mm, Da = 11 mm, L = 5000 mm	■	■	■								1321563A
	Di = 6 mm, Da = 11 mm, L = 25000 mm	■	■	■								1321564A
Di = 8 mm, Da = 13 mm, L = 20000 mm, DIN 73379, with textile ply	■	■	■									1321688B
	Molded hose											
	Di min = 4.5 mm, Di max = 7.5 mm, with reduction, 90°				■	■	■	■	■	■		1319718A
	Molded fuel hose											
	Di min = 3.5 mm, Di max = 4.5 mm, RME-resistant, with reduction, 90°				■	■	■	■	■	■		1319677A



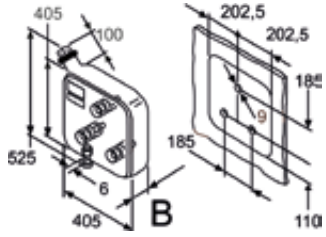
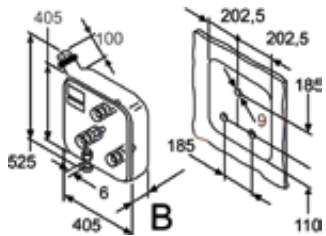

Fuel System

	DBW 2010/2016	Thermo 230/300/350	Thermo S 230/300/350/400	Air Top 2000 STC	Air Top Evo 40/55	Thermo Top Evo	Thermo Pro 50 Eco	Thermo Top C/E	Thermo Pro 90	Thermo Top Pro 120/150	Order number
	Fuel hose										
	Da = 5 mm, PA12 ETFE										
				■	■	■	■	■	■		9028520A
	Di = 3 mm, L = 12000 mm, blue, with white imprint, for Thermo Pro 90 at a pressure line length of 5 m										
				■	■	■	■	■	■	■	9030532A
	Di = 1.5 mm, L = 10000 mm, black										
				■	■	■	■	■	■	■	9030538A
	L = 8000 mm, black										
			■	■	■	■	■	■	■	9030540A	
L = 11000 mm, black											
			■	■	■	■	■	■	■	9030542A	
Di = 1.5 mm, L = 6000 mm, black											
			■	■	■	■	■	■	■	9030543A	
Di = 1.5 mm, L = 3000 mm, black											
			■	■	■	■	■	■	■	9030545A	
Di = 1.5 mm, L = 1500 mm, black											
	Metal fuel line kit for boats										
	Da = 5 mm, L = 5000 mm, EN ISO 7840 with screw fasteners, hoses and clips										
			■	■	■	■	■	■	■	669588	
	Fuel line for boats										
	Di = 1.5 mm, Da = 5 mm, L = 5000 mm, stainless steel										
			■	■	■	■	■	■	■	1320860A	
	Fuel pump hanger kit										
	also for fastening to stud bolts belonging to the vehicle, for dosing pump DP2 and DP30										
			■	■		■	■	■		92296A	
	Fuel pump holder										
	solid rubber, very quiet mounting, bag of 3 pieces										
			■	■		■	■	■		9023386A	



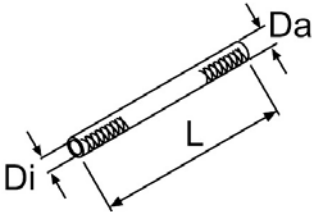

Fuel System

		DBW 2010/2016	Thermo 230/300/350	Thermo S 230/300/350/400	Air Top 2000 STC	Air Top Evo 40/55	Thermo Top Evo	Thermo Pro 50 Eco	Thermo Top C/E	Thermo Pro 90	Thermo Top Pro 120/150	Order number
	Tank extracting device, riser pipe Di = 2.6 mm, Da = 5 mm, L = 650 mm, steel zinc coated, 90° extractor connection piece, only for installation in metal tanks				■	■	■	■	■	■		1320399A
	Fuel tank L = 405 mm, W = 94 mm, plastic PE-LD, 12 liters	■			■	■	■	■	■	■		1322707B
	Fuel tank L = 405 mm, W = 200 mm, 24 liters, plastic PE-LD, with assembly kit				■	■	■	■	■	■		1322531A
	Fuel tank installation kit steel zinc coated, for 12-liter tank 1322707B				■	■	■	■	■	■		9025761A
	Hose sealing cone											
	Da = 5 mm, L = 30 mm	■	■	■								1319305A
	Da = 6 mm, L = 30 mm	■	■	■								1319702A
	Da = 8 mm, L = 32 mm	■	■	■								1320233A

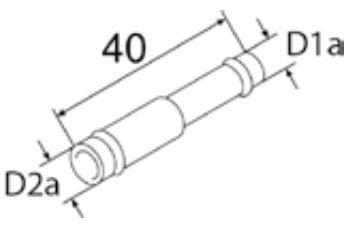

Fuel System

		DBW 2010/2016	Thermo 230/300/350	Thermo S 230/300/350/400	Air Top 2000 STC	Air Top Evo 40/55	Thermo Top Evo	Thermo Pro 50 Eco	Thermo Top C/E	Thermo Pro 90	Thermo Top Pro 120/150	Order number
	Interchangeable filter KC 74-089											
	For holders 1319823A and 1320016A	■	■	■								1320015A
	Interchangeable RME filter											
	For holder 1320017A	■	■	■								1320018A
	Molded fuel hose											
	Di = 4.5 mm, Da = 10.5 mm, 90°					■	■	■	■	■	■	9023160A
	VOME-resistant					■	■	■	■	■	■	9023384A
	Fuel hose											
	Di = 4.5 mm, Da = 10.5 mm											
	L = 5000 mm, VOME-resistant					■	■	■	■	■	■	1321612B
	L = 10000 mm, VOME-resistant					■	■	■	■	■	■	1321613A
	L = 50 mm, bag of 20 pieces					■	■	■	■	■		9023450A
	Fuel hose											
	Di = 3.5 mm, Da = 4.5 mm, L = 50 mm, RME-resistant, with reduction					■	■	■	■	■		1320862A

Fuel System

		DBW 2010/2016	Thermo 230/300/350	Thermo S 230/300/350/400	Air Top 2000 STC	Air Top Evo 40/55	Thermo Top Evo	Thermo Pro 50 Eco	Thermo Top C/E	Thermo Pro 90	Thermo Top Pro 120/150	Order number
	Reducer pipe D1a = 6 mm, D2a = 8 mm, L = 40 mm, brass	■	■	■								1319590A
	Molded hose Di = 4.5 mm, Da = 10.5 mm, 180°				■	■	■	■	■	■		1319686A
	Screw fittings kit steel zinc coated, for soldered joints, Contents: double connection piece, union nuts, ring seals and sealing cone	■	■	■								1320539A
	Riser pipe Di = 3 mm, Da = 6 mm, L = 322 mm, plastic				■	■	■	■	■	■		1320413A
	Support sleeve for reinforcing plastic pipes											
	Da = 6 mm, L = 15 mm, brass, bag of 10 pieces	■	■	■	■	■	■	■	■	■		1321071A
	Da = 7 mm, L = 36 mm	■	■	■	■	■	■	■	■	■		1320164A
	Da = 8 mm, L = 15 mm	■	■	■	■	■	■	■	■	■		1320198A

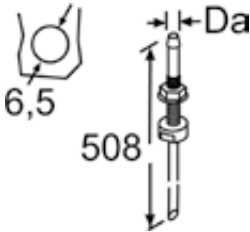
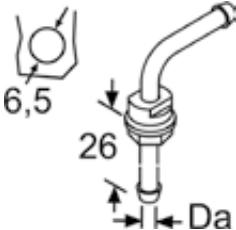

Fuel System

		DBW 2010/2016	Thermo 230/300/350	Thermo S 230/300/350/400	Air Top 2000 STC	Air Top Evo 40/55	Thermo Top Evo	Thermo Pro 50 Eco	Thermo Top C/E	Thermo Pro 90	Thermo Top Pro 120/150	Order number
	<p>Tank extracting device, riser pipe</p> <p>Da = 6 mm, L = 630 mm, steel zinc coated, with return, 90° extractor connection piece, only for installation in metal tanks</p>	■	■	■								1322830B
	<p>Tank extracting device, riser pipe</p> <p>Di = 2.4 mm, Da = 4.2 mm, L = 440 mm, stainless steel, Extractor connection piece, 39 mm long, vertical, for mounting in tank fitting, suitable for plastic tank and metal tank, M6</p>				■	■	■	■	■	■		1322645A
	<p>Tank extracting device</p> <p>Di = 2.4 mm, Da = 4.2 mm, L = 26 mm, steel zinc coated, Extractor connection piece angled at 90°, for mounting in tank fitting, suitable for plastic tank and metal tank, short riser pipe, M6</p>				■	■	■	■	■	■		1322827A
	<p>Tank extracting device</p> <p>Di = 3 mm, Da = 5 mm, L = 39 mm, steel zinc coated, with mounting parts for installation in tank fittings with length compensation</p>				■	■	■	■	■	■		9008021A
	<p>Tank extracting device</p> <p>Di = 3 mm, Da = 5 mm, stainless steel, for fitting in tank ventilation line</p>											
	L = 500 mm				■	■	■	■	■	■		1320836A
	L = 750 mm				■	■	■	■	■	■		1321824B

Fuel System

		DBW 2010/2016	Thermo 230/300/350	Thermo S 230/300/350/400	Air Top 2000 STC	Air Top Evo 40/55	Thermo Top Evo	Thermo Pro 50 Eco	Thermo Top C/E	Thermo Pro 90	Thermo Top Pro 120/150	Order number
	Fuel hose Di = 6 mm, Da = 12 mm, L = 10000 mm, black, Biodiesel or FAME resistant										■	9036443A
	Fuel connection kit L 2 Banjo bolts DIN7643 10-3, 2 Banjo connections M14x1.5, 4 hose clamps, 4 sealing rings										■	9035490A
	Fuel connection kit S 2 Banjo bolts DIN7643 6-3 S, 2 Banjo connections M10x1, 2 hose clamps, 4 sealing rings										■	9035486A
	Fuel Filter cpl. Da = 76 mm, H = 108 mm, KC 20										■	9036520A
	Fuel filter KC20 for holder 9036520A										■	9036522A

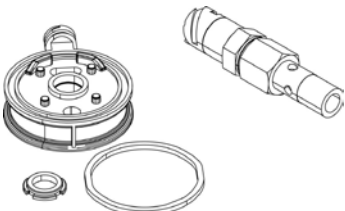

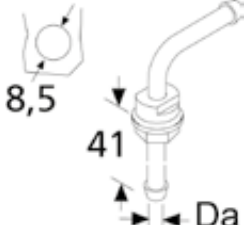

Fuel System

		DBW 2010/2016	Thermo 230/300/350	Thermo S 230/300/350/400	Air Top 2000 STC	Air Top Evo 40/55	Thermo Top Evo	Thermo Pro 50 Eco	Thermo Top C/E	Thermo Pro 90	Thermo Top Pro 120/150	Order number
	Heating adapter											
	Heating adapter, protection cap, gasket										■	9036523A
	Retrofit heating adapter											
	heating adapter, temperature switch, 3 pin electrical connector, technical documentation										■	9037295A
	Ring Connection Piece											
	Di = 14 mm, L = 56 mm, low pressure										■	1319810A
	Bag connection parts											
	2 compression rings BS-8, 2 pipe nozzle junctions 8-6, 2 coupling nuts A3-L8										■	9038207A
	Fuel extractor, T-piece											
	L = 50 mm, steel											
	H = 3.5 mm, 8 x 6 x 8										■	9035126A
	H = 3.8 mm, 10 x 6 x 10										■	9035128A
	H = 4 mm, 12 x 6 x 12										■	9035129A

Fuel System

	DBW 2010/2016	Thermo 230/300/350	Thermo S 230/300/350/400	Air Top 2000 STC	Air Top Evo 40/55	Thermo Top Evo	Thermo Pro 50 Eco	Thermo Top C/E	Thermo Pro 90	Thermo Top Pro 120/150	Order number
 <p data-bbox="523 689 710 712">Tank extracting device</p> <p data-bbox="523 723 742 745">Di = 4 mm, Da = 6 mm, steel</p>											<p data-bbox="1297 723 1316 745">■</p> <p data-bbox="1353 723 1436 745">9035099A</p>



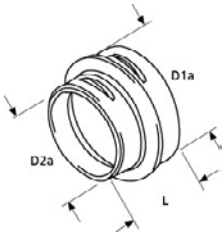

Hot Air System

		Air Top Evo 40/55	Dual Top Evo	Air Top 2000 STC	Order number
	Elbow				
	Da = 90 mm, black, plastic	■	■		1320706A
	Elbow				
	steel corrosion-resistant, 90°				
	Di = 80.5 mm, Da = 79 mm, L = 115 mm	■	■		1319272A
	Di = 102.5 mm, Da = 99 mm, L = 142 mm	■	■		1319273A
	T-piece				
	L = 110 mm, black, plastic				
	Da = 60 mm	■	■	■	1320474A
	Da = 90 mm	■	■		1320473A
	T-piece				
	Di = 90 mm, Da = 60 mm, black, plastic, with thread	■	■	■	1320476A
	Adapter for heater connection				
	L = 40 mm, black, plastic				
	D1a = 75 mm, D2a = 60 mm			■	1321005A
	D1a = 90 mm, D2a = 80 mm	■			1320186A

Hot Air System

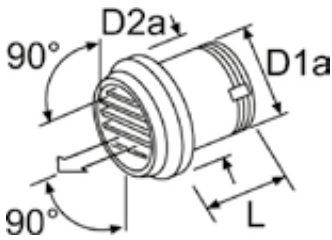
		Air Top Evo 40/55	Dual Top Evo	Air Top 2000 STC	Order number
	Adaptor ring				
	W = 17 mm				
	Di = 55 mm, Da = 60 mm, aluminium	■	■	■	1320224A
	Di = 70 mm, Da = 80 mm, black, plastic, for outlet 1319946A	■	■		1320040A
	Air ducting silencer				
	Di = 90 mm, L = 600 mm, aluminium/plastic	■	■		1321734A
	Air outlet				
	plastic, lockable, bag with wall feed through				
	Da = 60 mm, black	■	■	■	1320206A
	Da = 60 mm, white	■	■	■	1320207A
	Da = 60 mm, grey	■	■	■	1320937A
	Da = 90 mm, black	■	■		1320355A
	Da = 90 mm, white	■	■		1320713A
Da = 90 mm, grey	■	■		1320714A	
	Air outlet				
	plastic, axiale flow, bag with wall feed through				
	Da = 60 mm, black	■	■	■	1320934A
	Da = 60 mm, white	■	■	■	1320935A
	Da = 60 mm, grey	■	■	■	1320936A
	Da = 90 mm, grey	■	■		1320711A
	Da = 90 mm, white	■	■		1320712A
Da = 90 mm, black	■	■		1320932A	
	Air outlet				
	Da = 60 mm, D1a = 60 mm, D2a = 60 mm, L = 62 mm, black, plastic, axiale flow, bag with wall feed through	■		■	1322634A





Hot Air System

		Air Top Evo 40/55	Dual Top Evo	Air Top 2000 STC	Order number
	Air outlet				
	D1a = 80 mm, D2a = 110 mm, L = 65 mm, black, plastic, insert grid, straight, rotating, 90°	■	■		1322710A
	Air outlet				
	plastic, through flow with bushing, 45°				
	Da = 60 mm, black	■	■	■	1320204A
	Da = 60 mm, white	■	■	■	1320205A
	Da = 60 mm, brown	■	■	■	1320761A
	Da = 60 mm, grey	■	■	■	1320933A
	Da = 90 mm, grey	■	■		1320354A
Da = 90 mm, black	■	■		1320709A	
Da = 90 mm, white	■	■		1320710A	
	Air outlet				
	Da = 90 mm, L = 65 mm, black, plastic, through flow with bushing, 45°	■	■		1320956A
	Air outlet				
	D1a = 60 mm, D2a = 92 mm, L = 98, black, plastic, rotatable, with bushing, with ball-type cover	■	■	■	1322405A
	Air outlet				
	D2a = 100 mm, L = 65 mm, black, plastic, lockable, bag with wall feed through				
	D1a = 55 mm	■	■	■	1320812A
D1a = 70 mm, use for secondary flow only	■	■		1319946A	

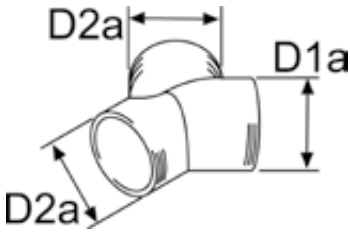

Hot Air System

		Air Top Evo 40/55	Dual Top Evo	Air Top 2000 STC	Order number
	Clamp For Bowden Cable 1320785A and 1320786A	■	■	■	1319688A
	Console For mounting flexible pipes with corresponding hose clip	■	■	■	1321044A
	Control cable with grip and outer sleeve, for distributor 1319224A und 1319214A				
	L = 850 mm	■	■	■	1320785A
	L = 1500 mm	■	■	■	1320786A
	Control device for distributor L = 2000 mm, for distributor 1320352A and 1320926A, with control butterfly valve	■	■	■	1319868A
	Demist nozzle Da = 55 mm, steel corrosion-resistant	■	■	■	1319470A

Hot Air System

		Air Top Evo 40/55	Dual Top Evo	Air Top 2000 STC	Order number
	Distributor Y-unit				
	black, plastic				
	Da = 55 mm	■	■	■	1319416A
	Da = 80 mm	■	■		1319212A
	Distributor Y-unit				
	black, plastic				
	D1a = 60 mm, D2a = 60 mm	■	■	■	1320814A
	D1a = 80 mm, D2a = 55 mm, to be used in the secondary flow only	■	■		1320753A
	D1a = 80 mm, D2a = 60 mm	■	■		1320471A
	D1a = 90 mm, D2a = 80 mm	■	■		1320375A
	D1a = 90 mm, D2a = 90 mm	■	■		1320470A
	Distributor				
	black, plastic, with remote control flap valve				
	Da = 55 mm, L = 95 mm	■	■	■	1319224A
	Da = 80 mm, L = 124 mm	■	■		1319214A
	Distributor				
	black, plastic, with control butterfly valve				
	Di = 60 mm	■	■	■	1320352A
	Di = 90 mm	■	■		1320926A
	Double fitting				
	black, plastic, for connecting flexible pipes				
	Da = 60 mm, L = 50 mm	■	■	■	1320469A
	Da = 80 mm, L = 75 mm	■	■		1319476A
	Da = 90 mm, L = 50 mm	■	■		1319869A

Hot Air System



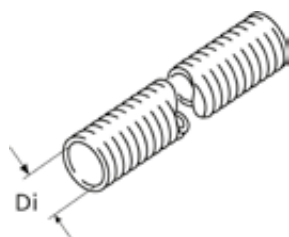

		Air Top Evo 40/55	Dual Top Evo	Air Top 2000 STC	Order number
	Dual Top air intake cover				
	Di = 60 mm, black, plastic		■		1314904A
	End Cap				
	black, plastic				
	Da = 60 mm	■	■	■	1320477A
	Da = 90 mm	■	■		1319870A

Hot Air System



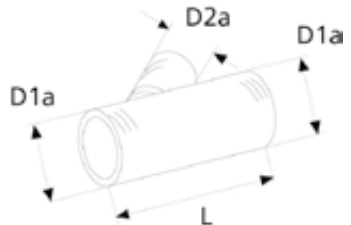

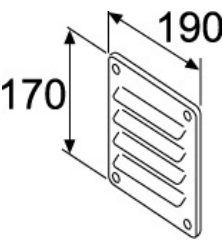
	Air Top Evo 40/55	Dual Top Evo	Air Top 2000 STC	Order number
Flexible exhaust pipe, two-ply				
Di = 55 mm, L = 25000 mm, grey, PAK	■	■	■	1311896C
Di = 80 mm, L = 25000 mm, grey, PAK	■	■		1311900C
Di = 55 mm, L = 20000 mm, AA	■		■	1321503A
Di = 80 mm, L = 1000 mm, AA	■			1321531A
Di = 80 mm, L = 5000 mm, AA	■			1321532A
Di = 80 mm, L = 10000 mm, AA	■			1321533A
Di = 55 mm, L = 2000 mm, grey, PAK	■	■	■	1321580B
Di = 55 mm, L = 5000 mm, grey, PAK	■	■	■	1321581B
Di = 55 mm, L = 10000 mm, grey, PAK	■	■	■	1321722B
Di = 60 mm, L = 2000 mm, grey, PAK	■	■	■	1321504A
Di = 60 mm, L = 5000 mm, grey, PAK	■	■	■	1321505A
Di = 60 mm, L = 10000 mm, grey, PAK	■	■	■	1321727C
Di = 60 mm, L = 25000 mm, grey, PAK	■	■	■	1311898C
Di = 80 mm, L = 2000 mm, grey, PAK	■	■		1321582B
Di = 80 mm, L = 5000 mm, grey, PAK	■	■		1321583B
Di = 80 mm, L = 10000 mm, grey, PAK	■	■		1321729B
Di = 90 mm, L = 2000 mm, grey, PAK	■	■		1321506B
Di = 90 mm, L = 5000 mm, grey, PAK	■			1321508A
Di = 90 mm, L = 25000 mm, grey, PAK	■	■		1311902C
Di = 90 mm, L = 10000 mm, grey, PAK	■	■		1321731C
Di = 60 mm, L = 3000 mm, PAHK	■		■	1321511A
Di = 55 mm, L = 10000 mm, PAK	■		■	1321701B
Di = 55 mm, L = 20000 mm, PAK	■		■	1321703B
Di = 80 mm, L = 10000 mm, PAK	■			1322147B
Di = 55 mm, L = 2000 mm, black, APK	■	■	■	1315889A
Di = 55 mm, L = 5000 mm, black, APK	■	■	■	1321573B
Di = 55 mm, L = 10000 mm, black, APK	■	■	■	1322082A
Di = 55 mm, L = 25000 mm, black, APK	■	■	■	1311891C
Di = 60 mm, L = 2000 mm, black, APK	■	■	■	1321574B
Di = 60 mm, L = 5000 mm, black, APK	■	■	■	1321575C
Di = 60 mm, L = 10000 mm, black, APK	■	■	■	1322083C
Di = 60 mm, L = 25000 mm, black, APK	■	■	■	1311892C
Di = 80 mm, L = 2000 mm, black, APK	■	■		1321576C
Di = 80 mm, L = 5000 mm, black, APK	■	■		1321577B
Di = 80 mm, L = 10000 mm, black, APK	■	■		1321718C
Di = 80 mm, L = 25000 mm, black, APK	■	■		1311893C
Di = 90 mm, L = 2000 mm, black, APK	■	■		1321578C
Di = 90 mm, L = 5000 mm, black, APK	■	■		1321579C
Di = 90 mm, L = 10000 mm, black, APK	■	■		1321719C
Di = 90 mm, L = 25000 mm, black, APK	■	■		1311894C

Hot Air System

	Air Top Evo 40/55	Dual Top Evo	Air Top 2000 STC	Order number
	Insulated hose			
	L = 12000 mm, PAK			
	Di = 80 mm	■	■	1321515A
Di = 90 mm	■	■	1321517A	
	Junction fitting			
	D2a = 60 mm, black, plastic, 45°			
	D1a = 60 mm, L = 145 mm	■	■	1320472A
D1a = 90 mm, L = 146 mm	■	■	1320707A	
	Junction fitting			
	Da = 80 mm, L = 370 mm, steel corrosion-resistant, 45°			
	Louvre plate			
L = 190 mm, H = 170 mm, aluminium				■ ■ ■ 1319269A
	Protective screen			
	Di = 60 mm, rubber, for heater intake			
		■		1320173A

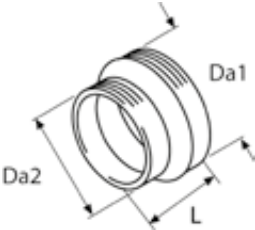
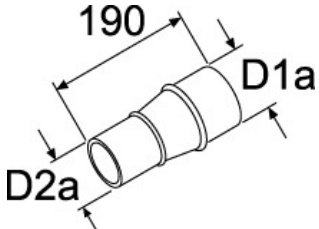
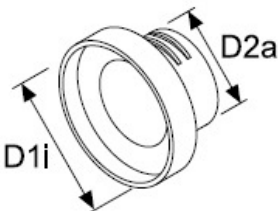



Hot Air System

	Air Top Evo 40/55	Dual Top Evo	Air Top 2000 STC	Order number
	Reducer pipe			
	black, plastic, for flexible pipe			
			■	1320127A
		■	■	1319477A
	■	■	1320185A	
	Reducer pipe			
		■		1319312A
	Reduction adapter			
	Di = 90 mm, black, plastic, for connecting flexible pipes			
		■	■	1320760A
	■	■	1320925A	
	Rubber bellow			
		■		9018647C
	Screen			
			■	1320163A



Hot Air System

	Air Top Evo 40/55	Dual Top Evo	Air Top 2000 STC	Order number
	Screen (anti-ingress)			
	Di = 80 mm, Da = 112 mm, steel chromed			1319308A
	Union nut for outlet			
	L = 60 mm, black, plastic			
	Da = 60 mm	■	■	1320922A
	Da = 90 mm	■	■	1320468A
	Wall feed-through			
	black, plastic			
	Da = 60 mm	■	■	1320923A
	Da = 90 mm	■	■	1320924A
	Wall pipe			
	L = 73 mm, black, plastic			
	D1a = 87 mm, D2a = 55 mm	■	■	1320063A
	D1a = 110 mm, D2a = 80 mm	■	■	1319471A

Water System

	Air Top 2000 STC	Air Top Evo 40/55	Thermo Top Evo	Thermo Pro 50 Eco	Thermo Top C/E	Thermo Pro 90	DBW 2010/2016	Thermo 230/300/350	Thermo S 230/300/350/400	Thermo Top Pro 120/150	Order number		
 <p>Braided protection hose Di min = 26 mm, Di max = 30 mm, polyester</p>													
											L = 1500 mm, chafing guard for polyester water hoses	1322409A	
											L = 2000 mm, chafing guard for polyester water hoses	1322513A	
											L = 5000 mm	1321596B	
											L = 25000 mm	1321597B	
 <p>Connecting piece Da = 18 mm, L = 75 mm, steel corrosion-resistant</p>													
												1319266A	
 <p>Connecting pipe Da = 38 mm, L = 100 mm, steel corrosion-resistant, for thermostat</p>													
												1319286A	
 <p>Connecting pipe L = 65 mm, steel corrosion-resistant, for thermostat</p>													
												Da = 15 mm	1319263A
												Da = 18 mm	1319519A
 <p>Connecting pipe Di = 15 mm, L = 75 mm, brass</p>													
												1319279A	

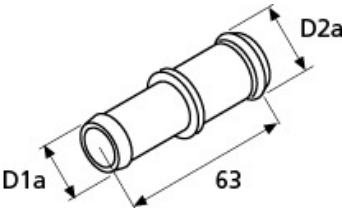
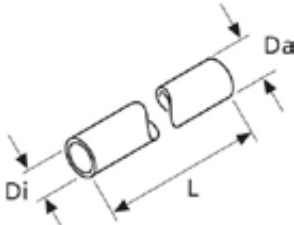
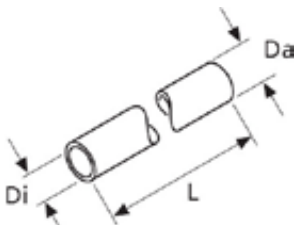
Water System

	Air Top 2000 STC	Air Top Evo 40/55	Thermo Top Evo	Thermo Pro 50 Eco	Thermo Top C/E	Thermo Pro 90	DBW 2010/2016	Thermo 230/300/350	Thermo S 230/300/350/400	Thermo Top Pro 120/150	Order number
 <p>Connecting pipe L = 63 mm</p>											
			■	■	■	■	■	■	■		1320143A
			■	■	■	■	■	■	■		1320155A
			■	■	■	■	■	■	■		1319722A
			■	■	■	■	■	■	■		1319594A
 <p>Hose Di = 15 mm, Da = 22 mm, L = 2400 mm</p>			■	■	■	■	■	■			1320300A
 <p>Hose Di = 18 mm, Da = 25 mm, L = 2000 mm, PER-EPDM</p>			■								1322423A
 <p>Filter insert Da = 38 mm, for shutoff valve with filter 1319931A</p>							■	■			1319710A
 <p>Molded hose Di = 18 mm, Da = 25 mm, 90°</p>			■	■	■	■	■				1319418A

Water System

		Air Top 2000 STC	Air Top Evo 40/55	Thermo Top Evo	Thermo Pro 50 Eco	Thermo Top C/E	Thermo Pro 90	DBW 2010/2016	Thermo 230/300/350	Thermo S 230/300/350/400	Thermo Top Pro 120/150	Order number
	Molded hose											
	Di = 18 mm, Da = 25 mm			■	■	■	■	■				1319401A
	Di = 20 mm, Da = 27 mm			■	■	■	■	■				1319623A
	Molded hose											
	Di = 18 mm, Da = 25 mm			■	■	■	■	■	■	■		1320758A
	Molded hose											
	Di = 18 mm, Da = 25 mm			■	■	■	■	■	■	■		1319419A
	Molded hose											
	D1a = 25 mm, D2a = 25 mm, with reduction			■	■	■	■	■	■	■		1320871A
	Molded hose											
	Di = 20 mm, Da = 28 mm, 180°			■	■	■	■	■	■	■		1320156A

Water System

		Air Top 2000 STC	Air Top Evo 40/55	Thermo Top Evo	Thermo Pro 50 Eco	Thermo Top C/E	Thermo Pro 90	DBW 2010/2016	Thermo 230/300/350	Thermo S 230/300/350/400	Thermo Top Pro 120/150	Order number
	Molded hose											
	D1a = 22 mm, D2a = 25 mm, with reduction			■	■	■	■	■	■	■		1319402A
	Molded hose											
	Da = 25 mm, 180°											
	Di = 15 mm, L = 580 mm, H = 75 mm				■	■		■				1320790A
	Di = 18 mm, L = 580 mm				■	■	■	■				1319421A
	Di = 18 mm, L = 1100 mm, H = 75 mm				■	■	■	■				1322496A
	Molded hose											
	Di = 18 mm, Da = 25 mm, L = 110 mm, 180°			■	■	■	■	■				1322493A
	Molded hose											
	360°											
	Di = 18 mm, Da = 25 mm, L = 2200 mm				■	■	■	■	■			1319455A
	Di = 18 mm, Da = 25 mm, L = 3000 mm				■	■	■	■	■			1320783A
	Di = 20 mm, Da = 27 mm, L = 2200 mm				■	■	■	■	■			1319268A
	Molded hose											
	Di = 20 mm, Da = 29 mm, L = 2230 mm, with increased wall thickness, 360°				■	■	■	■	■		■	1319631A



Water System

	Air Top 2000 STC	Air Top Evo 40/55	Thermo Top Evo	Thermo Pro 50 Eco	Thermo Top C/E	Thermo Pro 90	DBW 2010/2016	Thermo 230/300/350	Thermo S 230/300/350/400	Thermo Top Pro 120/150	Order number
 <p>Molded hose 90°</p> <p>Di = 15 mm, Da = 22 mm, L = 1020 mm</p> <p>Di = 18 mm, Da = 25 mm, L = 125 mm</p> <p>Di = 18 mm, Da = 25 mm, L = 500 mm</p> <p>Di = 18 mm, Da = 27 mm, L = 1020 mm</p> <p>Di = 20 mm, Da = 27 mm, L = 130 mm</p> <p>Di = 20 mm, Da = 27 mm, L = 1020 mm</p>											
			■	■	■	■	■	■	■		1320789A
			■	■	■	■	■	■	■		1320907A
			■	■	■	■	■	■	■		1319953A
			■	■	■	■	■	■	■		1320794A
			■	■	■	■	■	■	■		1320147A
			■	■	■	■	■	■	■		1319839A
 <p>Molded hose Di = 38 mm, Da = 47 mm, L = 70 mm, silicone, 90°</p>								■	■		1319934A
 <p>Molded hose Di = 15 mm, Da = 25 mm, silicone, 90°</p>			■	■	■	■	■	■	■		1319717A
 <p>Molded hose Da = 47 mm, silicone, with reduction, 90°</p>								■	■		1319827A
 <p>Molded hose D1a = 44 mm, D2a = 47 mm, silicone, with reduction, 90°</p>								■	■		1319679A

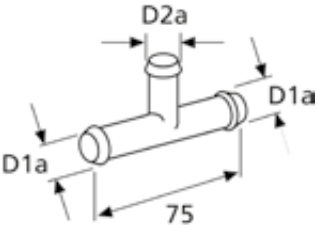
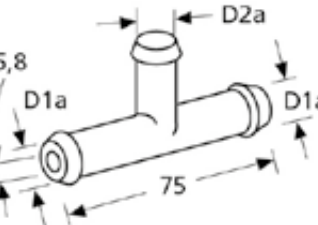

Water System

		Air Top 2000 STC	Air Top Evo 40/55	Thermo Top Evo	Thermo Pro 50 Eco	Thermo Top C/E	Thermo Pro 90	DBW 2010/2016	Thermo 230/300/350	Thermo S 230/300/350/400	Thermo Top Pro 120/150	Order number
	Molded hose Di = 20 mm, Da = 27 mm, L = 59 mm, with reduction, 90°			■	■	■	■	■	■	■		1319673A
	Molded hose Di = 20 mm, Da = 27 mm, L = 64 mm, W = 47 mm, 180°			■	■	■	■	■	■	■		1320913A
	Reducing hose D1a = 27 mm, D2a = 25 mm, L = 60 mm			■	■	■	■	■	■	■		1320856A
	Reducing hose D1a = 37 mm, D2a = 47 mm, L = 100 mm, silicone							■	■			1320374A
	Thermo Top Evo holding bracket kit For fastening water connection piece of Thermo Top Evo, with seals and screw			■	■							1322832A





Water System

	Air Top 2000 STC	Air Top Evo 40/55	Thermo Top Evo	Thermo Pro 50 Eco	Thermo Top C/E	Thermo Pro 90	DBW 2010/2016	Thermo 230/300/350	Thermo S 230/300/350/400	Thermo Top Pro 120/150	Order number
 <p>T-piece L = 75 mm</p>											
D1a = 15 mm, D2a = 15 mm, steel corrosion-resistant			■	■	■	■	■	■	■		1319289A
D1a = 18 mm, D2a = 15 mm, steel corrosion-resistant			■	■	■	■	■	■	■		1320532A
D1a = 18 mm, D2a = 18 mm, black, plastic			■	■	■	■	■	■	■		1321001A
D1a = 20 mm, D2a = 15 mm, steel corrosion-resistant			■	■	■	■	■				1319290A
D1a = 20 mm, D2a = 10 mm, steel corrosion-resistant			■	■	■	■	■	■	■		1319846A
D1a = 20 mm, D2a = 20 mm, brass			■	■	■	■	■				1319602A
 <p>T-piece D1a = 20 mm, D2a = 20 mm, L = 75 mm, steel corrosion-resistant, with restrictor, restrictor diameter 5.8 mm</p>			■	■	■	■	■	■			1319817A
 <p>T-piece Da = 18 mm, L = 75 mm, steel corrosion-resistant, with restrictor, restrictor diameter 4 mm</p>			■	■	■	■	■	■			1319800A
 <p>Hose extension kit 8 SPRING BAND CLAMPS, 2 CONNECTING PIPES 20x20</p>									■		9035488A

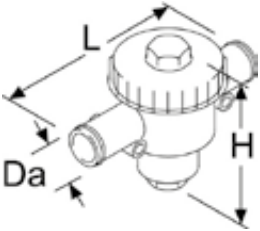

Valve

		Thermo Top Evo	Thermo Pro 50 Eco	Thermo Top C/E	Thermo Pro 90	DBW 2010/2016	Thermo 230/300/350	Thermo S 230/300/350/400	Thermo Top Pro 120/150	Order number
	Connecting pipe									
	L = 75 mm, steel corrosion-resistant, with bleeder valve									
	Da = 15 mm	■	■	■	■	■	■	■		1319221A
	Da = 18 mm	■	■	■	■	■	■	■		1319219A
	Da = 20 mm	■	■	■	■	■	■	■		1320989A
	Check valve									
	black, plastic, without leak hole									
	Da = 15 mm, L = 104 mm	■	■	■	■	■	■	■		1320239A
	Da = 15 mm, L = 104 mm	■	■	■	■	■	■	■		1320240A
	Da = 18 mm, L = 90 mm	■	■	■	■	■	■	■		1319250A
	Da = 18 mm, L = 100 mm	■	■	■	■	■	■	■		1319484A
	Da = 20 mm, L = 120 mm	■	■	■	■	■	■	■		1319554A
	Check valve									
	Da = 18 mm, L = 104 mm, black, plastic, without leak hole	■	■	■	■	■	■	■		1320563A
	Check valve									
	H = 42 mm									
	D1a = 18 mm, D2a = 18 mm, L = 146 mm, black, plastic, without leak hole	■	■	■	■	■	■	■		1319485A
	D1a = 18 mm, D2a = 18 mm, L = 146 mm, black, plastic, with leak hole	■	■	■	■	■	■	■		1319486A
	D1a = 20 mm, D2a = 20 mm, L = 162 mm, brass, with leak hole	■	■	■	■	■	■	■		1319595A
	Check valve									
	D1a = 18 mm, D2a = 18 mm, L = 82 mm, H = 82 mm, black, plastic, with bypass, without leak hole	■	■	■	■	■	■	■		1319255A



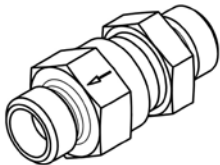
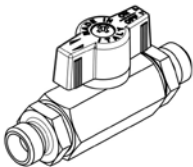

Valve

		Thermo Top Evo	Thermo Pro 50 Eco	Thermo Top C/E	Thermo Pro 90	DBW 2010/2016	Thermo 230/300/350	Thermo S 230/300/350/400	Thermo Top Pro 120/150	Order number
	<p>Combination valve</p> <p>Da = 18 mm, brass / steel coated, with leak hole, starts to open at 40 °C</p>	■	■	■	■	■	■	■		1319650A
	<p>Shutoff valve</p> <p>Da = 38 mm, L = 200 mm, W = 85.5 mm, H = 131 mm, plastic PA66, Operating pressure -0.5 to 4 bar, fluid temperature -30 to 110 °C, weight 0.5 kg, with filter</p>						■	■		1319931A
	<p>Electric valve</p> <p>24 V, Ambient temperature -40 °C to +80 °C, for 6.3 mm tab connectors, for fuel line</p>					■	■	■		1319443A
	<p>Electric valve</p> <p>Da = 20 mm, L = 106 mm, H = 100 mm, 12 V, metal / plastic, 2/2-way, normally open, operating temperature -40 to 85 °C</p>	■	■	■	■	■	■	■		1319981A
	<p>Electric valve</p> <p>Da = 18 mm, L = 84 mm, W = 55 mm, H = 101 mm, 12 V, metal / plastic, 3/2-way, open without power</p>		■	■	■	■	■	■		9014606A

Valve

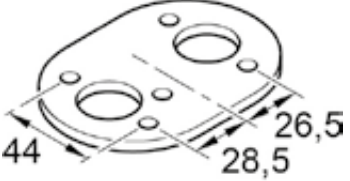
		Thermo Top Evo	Thermo Pro 50 Eco	Thermo Top C/E	Thermo Pro 90	DBW 2010/2016	Thermo 230/300/350	Thermo S 230/300/350/400	Thermo Top Pro 120/150	Order number
	Thermostatic valve									
	L = 108 mm, H = 70 mm, brass / steel coated, with leak hole, starts to open at 59 °C									
	Da = 18 mm	■	■	■	■	■	■	■		
	Da = 20 mm	■	■	■	■	■	■			
	Thermostatic valve									
	Da = 20 mm, L = 112 mm, brass / steel coated, without leak hole, starts to open at 70 °C	■	■	■	■	■	■	■		
	Check valve									
	opening pressure 0.2 bar, max pressure 25 bar, operating range -40 +100°C, connection M14 x 1.5							■		
	Low pressure ball valve									
	incl. 2 connections M14 x 1.5 / DIN 3852-2-A and 2 sealing rings							■		



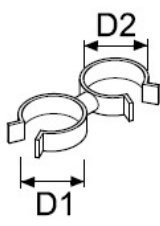

Mounting Parts

		Air Top 2000 STC	Air Top Evo 40/55	Thermo Top Evo	Thermo Pro 50 Eco	Thermo Top C/E	Thermo Pro 90	DBW 2010/2016	Thermo 230/300/350	Thermo S 230/300/350/400	Order number
	Air heater holding plate stainless steel, for reinforcement on thin body panels	■	■								1320995A
	Anti-vibration mount L = 34 mm, bag of 5 pieces, not suitable for fastening heaters										
	M6	■	■	■	■	■	■				9023020A
	M8	■	■		■	■	■				1319553A
	Anti-vibration mount L = 53 mm, M6, not suitable for fastening heaters	■	■	■	■	■	■				1320270A
	Cailleau hose clip stainless steel, mounting with special tool, 10 pieces										
	Di = 9.5 mm	■	■	■	■	■	■	■	■	■	9011661A
	Di = 10.5 mm	■	■	■	■	■	■	■	■	■	9011656A
	Dual lock velcro strip L = 50 mm, W = 25 mm, black, plastic, self-adhesive	■	■	■	■	■	■	■	■	■	1320202A

Mounting Parts

		Air Top 2000 STC	Air Top Evo 40/55	Thermo Top Evo	Thermo Pro 50 Eco	Thermo Top C/E	Thermo Pro 90	DBW 2010/2016	Thermo 230/300/350	Thermo S 230/300/350/400	Order number
	Edge protector										
	with wire coil, sheet thickness 1 to 4 mm										
	L = 500 mm	■	■	■	■	■	■	■	■	■	1319778A
	L = 700 mm	■	■	■	■	■	■	■	■	■	1320093A
	Holder for air heaters										
	stainless steel, suitable for various installation options	■	■								1319936A
	Hose and cable holder										
	black, plastic, bag of 5 pieces										
	D1 = 10 – 12, D2 = 19 – 24.5	■	■	■	■	■	■	■	■	■	9010999A
	Di = 22 mm, D1 = 22 – 24, D2 = 22 – 24	■	■	■	■	■	■	■	■	■	9011000A
	Di = 25 mm, D1 = 25 – 28, D2 = 21.5 – 24	■	■	■	■	■	■	■	■	■	9011001A
	Di = 27 mm, D1 = 27, D2 = 27, locking	■	■	■	■	■	■	■	■	■	9010997A
	Hose clip										
	bolt head with hexagon and cross-head slot										
	Di = 8 mm, steel corrosion-resistant, bag of 20 pieces	■	■	■	■	■	■	■	■	■	1320244A
	Di = 9 mm, steel corrosion-resistant	■	■	■	■	■	■	■	■	■	1320492A
	Di = 10 mm, steel corrosion-resistant, bag of 50 pieces	■	■	■	■	■	■	■	■	■	9023037A
	Di = 12 mm, steel corrosion-resistant, bag of 20 pieces	■	■	■	■	■	■	■	■	■	1320246A
	Di = 14 mm, steel corrosion-resistant, bag of 20 pieces	■	■	■	■	■	■	■	■	■	1320245A
Di = 14 mm, stainless steel, bag of 10 pieces	■	■	■	■	■	■	■	■	■	1320249A	





Mounting Parts

		Air Top 2000 STC	Air Top Evo 40/55	Thermo Top Evo	Thermo Pro 50 Eco	Thermo Top C/E	Thermo Pro 90	DBW 2010/2016	Thermo 230/300/350	Thermo S 230/300/350/400	Order number
	Hose clip										
	SW = 7, bolt head with hexagon and cross-head slot										
	Di min = 16 mm, Di max = 25 mm, steel corrosion-resistant, bag of 20 pieces	■	■	■	■	■	■	■	■	■	1320248A
	Di min = 16 mm, Di max = 27 mm, stainless steel, bag of 10 pieces	■	■	■	■	■	■	■	■	■	9015918A
	Di min = 23 mm, Di max = 35 mm, stainless steel, bag of 20 pieces	■	■	■	■	■	■	■	■	■	1320271A
Di min = 32 mm, Di max = 50 mm, steel corrosion-resistant, bag of 10 pieces	■	■	■	■	■	■	■	■	■	1321064A	
	Hose clip										
	Bolt head with hexagon and slot										
	Di = 40 mm, W = 14.3 mm, steel corrosion-resistant, SW = 8	■	■	■	■	■	■	■	■	■	1320158A
	Di = 48 mm, W = 14.3 mm, steel corrosion-resistant, SW = 8	■	■	■	■	■	■	■	■	■	1320159A
	Di = 70 mm, W = 14.3 mm, steel corrosion-resistant, SW = 8	■	■	■	■	■	■	■	■	■	1320223A
	Di = 72 mm, W = 14.3 mm, steel corrosion-resistant, SW = 8	■	■	■	■	■	■	■	■	■	1320160A
	Di = 78 mm, W = 12.7 mm, stainless steel, SW = 7	■	■	■	■	■	■	■	■	■	1320817A
	Di = 80 mm, W = 14.3 mm, steel corrosion-resistant, SW = 8	■	■	■	■	■	■	■	■	■	1320162A
Di = 98 mm, W = 14.3 mm, steel corrosion-resistant, SW = 8	■	■	■	■	■	■	■	■	■	1320161A	
	Housing cover										
	As replacement when using external temperature sensor, with grommet										1319621A
	Locking compound										
	red, 20 ml, for nuts and bolts	■	■	■	■	■	■	■	■	■	1320535A





Mounting Parts

		Air Top 2000 STC	Air Top Evo 40/55	Thermo Top Evo	Thermo Pro 50 Eco	Thermo Top C/E	Thermo Pro 90	DBW 2010/2016	Thermo 230/300/350	Thermo S 230/300/350/400	Order number
	Mounting base										
	H = 35 mm, aluminium / steel, for air heaters, for mounting air heaters on the vehicle floor, overall height of 35 mm makes them suitable for very thick carpets / mats / insulation or other cladding	■	■								1321444A
	Mounting bracket										
	L = 46 mm, W = 25 mm										
	stainless steel, bag of 10 pieces	■	■	■	■	■	■	■	■	■	1320264A
steel zinc coated, bag of 10 pieces	■	■	■	■	■	■	■	■	■	1320232A	
	Mounting strip										
	L = 100 mm, W = 25 mm										
	stainless steel	■	■	■	■	■	■	■	■	■	1319818A
steel zinc coated, bag of 10 pieces	■	■	■	■	■	■	■	■	■	9007918A	
	Pin lock										
	Da = 12.5 mm, steel corrosion-resistant, M6, bag of 10 pieces	■	■	■	■	■	■	■	■	■	9011659A
	Pipe clamp										
	W = 16 mm, stainless steel, for flexible exhaust pipe										
	Di = 24 mm, with carriage bolt	■		■	■	■					1320165A
Di = 26 mm, nut, welded		■								1320220A	



Mounting Parts

		Air Top 2000 STC	Air Top Evo 40/55	Thermo Top Evo	Thermo Pro 50 Eco	Thermo Top C/E	Thermo Pro 90	DBW 2010/2016	Thermo 230/300/350	Thermo S 230/300/350/400	Order number
	Pipe clamp										
	steel corrosion-resistant, for flexible exhaust pipe										
	Di = 24 , W = 10.4 mm, with screw	■		■	■	■					1320815A
	Di = 30 , Da = 33 , with carriage bolt						■				1320203A
	Di = 39 , W = 13.5 mm, with screw						■	■			1320194A
	Pipe clip										
	Di = 18 mm, W = 15 mm, steel zinc coated, 6.5 mm fastening hole	■	■	■	■	■	■	■	■	■	1320042A
	Di = 25 mm, W = 15 mm, stainless steel, 6.5 mm fastening hole, bag of 10 pieces	■	■	■	■	■	■	■	■	■	9023007A
	Di = 28 mm, W = 15 mm, steel zinc coated, 6.5 mm fastening hole, bag of 5 pieces	■	■	■	■	■	■	■	■	■	1320277A
	Di = 33 mm, W = 15 mm, stainless steel, 6.5 mm fastening hole	■	■	■	■	■	■	■	■	■	1320064A
	Di = 42 mm, W = 12 mm, stainless steel, 5.2 mm fastening hole	■	■	■	■	■	■	■	■	■	1319693A
	Di = 42 mm, W = 15 mm, stainless steel, 6.5 mm fastening hole, bag of 5 pieces	■	■	■	■	■	■	■	■	■	1320276A
	Di = 52 mm, W = 15 mm, steel zinc coated, 6.5 mm fastening hole, bag of 5 pieces	■	■	■	■	■	■	■	■	■	1320265A
	Pipe clip										
	rubber-coated pipe clip										
	Di = 5 mm, W = 12 mm, stainless steel, 5.2 mm fastening hole	■	■	■	■	■	■	■			1320195A
	Di = 29 mm, W = 15 mm, steel zinc coated, 6.4 mm fastening hole	■	■	■	■	■	■	■			1320235A
	Di = 34 mm, W = 15 mm, steel zinc coated, 6.4 mm fastening hole	■	■	■	■	■	■	■			1319701A
	Di = 34 mm, W = 20 mm, bag of 10 pieces, steel zinc coated, 8.4 mm fastening hole	■	■	■	■	■	■	■	■	■	1320236A
	Di = 35 mm, W = 20 mm, bag of 5 pieces, steel zinc coated, 8.4 mm fastening hole	■	■	■	■	■	■	■			9022835A
	Rivet-in nut										
	D1a = 13 mm, D2a = 9 mm, L = 15.5 mm, aluminium, bag of 10 pieces, M6	■	■	■	■	■	■	■	■	■	9011635A

Mounting Parts

		Air Top 2000 STC	Air Top Evo 40/55	Thermo Top Evo	Thermo Pro 50 Eco	Thermo Top C/E	Thermo Pro 90	DBW 2010/2016	Thermo 230/300/350	Thermo S 230/300/350/400	Order number
	Rubber ring (anti-chafing device)										
	not permitted for exhaust systems										
	Da = 31 mm, L = 15 mm, black, elastomer, bag of 10 pieces	■	■	■	■	■	■	■	■	■	1321063A
	Da = 40 mm, L = 20 mm, black, elastomer	■	■	■	■	■	■	■	■	■	1312785A
	Da = 45 mm, L = 20 mm, red, EPDM-50	■	■	■	■	■	■	■	■	■	1312780A
	Self-tapping screw										
	Da = 6 mm, L = 22 mm, steel zinc coated, bag of 10 pieces, SW = 10				■	■					9011669A
	Self-tapping stud bolt										
	steel zinc coated, bag of 10 pieces, M6										
	L = 16 mm				■	■					9006446A
	L = 31 mm				■	■					9009025A
	Spacer bushing										
	aluminium										
	Di = 7 mm, Da = 18 mm, L = 8 mm	■	■	■	■	■	■	■	■	■	1320091A
	Di = 8 mm, Da = 20 mm, L = 5 mm	■	■	■	■	■	■	■	■	■	1320498A
	Di = 8 mm, Da = 20 mm, L = 8 mm	■	■	■	■	■	■	■	■	■	1320499A
	Di = 8 mm, Da = 20 mm, L = 10 mm	■	■	■	■	■	■	■	■	■	1320496A
	Di = 8 mm, Da = 20 mm, L = 15 mm	■	■	■	■	■	■	■	■	■	1320090A
	Di = 8 mm, Da = 20 mm, L = 20 mm	■	■	■	■	■	■	■	■	■	1320088A
	Di = 8 mm, Da = 20 mm, L = 30 mm	■	■	■	■	■	■	■	■	■	1320089A
Di = 8 mm, Da = 20 mm, L = 40 mm	■	■	■	■	■	■	■	■	■	1319533A	
Di = 9 mm, Da = 25 mm, L = 14 mm	■	■	■	■	■	■	■	■	■	1320092A	





Mounting Parts

	Air Top 2000 STC	Air Top Evo 40/55	Thermo Top Evo	Thermo Pro 50 Eco	Thermo Top C/E	Thermo Pro 90	DBW 2010/2016	Thermo 230/300/350	Thermo S 230/300/350/400	Order number
	Spacer nut									
	steel corrosion-resistant, SW = 17, M6									
		■	■	■	■	■	■	■	■	1320256A
	L = 20 mm	■	■	■	■	■	■	■	■	1320241A
	L = 30 mm	■	■	■	■	■	■	■	■	1320083A
L = 40 mm	■	■	■	■	■	■	■	■	1319517A	
	Spring clip									
	W = 12 mm, steel corrosion-resistant, bag of 10 pieces									
	Di = 22 mm, black, Space-saving clip, E2	■	■	■	■	■	■	■	■	9011662A
	Di = 25 mm, light grey	■	■	■	■	■	■	■	■	9009019A
	Di = 25 mm, black, Space-saving clip, E2	■	■	■	■	■	■	■	■	9009022A
	Di = 27 mm, dark grey	■	■	■	■	■	■	■	■	9009018A
	Di = 27 mm, black, Space-saving clip, E2	■	■	■	■	■	■	■	■	9009023A
Di = 28 mm, black, Space-saving clip, E1	■	■	■	■	■	■	■	■	9014607A	
	Holder									
	steel corrosion-resistant, standard holder			■	■					1320500A
	Holder									
	steel corrosion-resistant, for horizontal installation			■	■					1320495A
	Holder									
	steel corrosion-resistant, for vertical installation			■	■					1320494A





Mounting Parts

		Air Top 2000 STC	Air Top Evo 40/55	Thermo Top Evo	Thermo Pro 50 Eco	Thermo Top C/E	Thermo Pro 90	DBW 2010/2016	Thermo 230/300/350	Thermo S 230/300/350/400	Order number
	Union nut M14 x 1.5 connection thread, SW = 19, bag of 10 pieces							■	■	■	1320243A
	Air Top Box metal / plastic, for mounting Webasto air heaters on commercial vehicle bodies, with holder and mounting accessories	■	■								9005942B
	Installation box steel, with mounting parts		■								9016392B
	Installation box steel, enables additional installation options, including heating air adapter	■									86032A
	Installation box steel, with mounting parts	■									1311609B





Electrical Accessories

		Thermo Top C/E	Air Top 2000 STC	Air Top Evo 40/55	Thermo Top Evo	Thermo Pro 50 Eco	Thermo Pro 90	DBW 2010/2016	Thermo Top Pro 120/150	Dual Top Evo	eThermo Top Eco 20 P/30 P	Order number
	Adapter wiring harness											
	L = 1600 mm, for Thermo Top C coolant pump	■										1320279A
	Blade fuse											
	6.3 mm, bag of 20 pieces											
	15 A, light blue											9023139A
	20 A, brown											9023141A
	25 A, white											9023142A
	Blocking diode											
	3 A, with connection cables	■	■	■	■	■	■	■				1320826A
	Compartment thermostat											
	L = 75 mm, W = 28 mm, H = 75 mm, black, plastic, mechanical (changeover contact), for vehicle blower						■	■				1320587A
	Compartment thermostat											
	L = 75 mm, W = 28 mm, H = 75 mm, black, plastic, for vehicle blower, mechanical (changeover contact), with on/off switch						■	■				1320415A



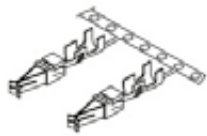

Electrical Accessories

		Thermo Top C/E	Air Top 2000 STC	Air Top Evo 40/55	Thermo Top Evo	Thermo Pro 50 Eco	Thermo Pro 90	DBW 2010/2016	Thermo Top Pro 120/150	Dual Top Evo	eThermo Top Eco 20 P/50 P	Order number
	Compartment thermostat L = 75 mm, W = 28 mm, H = 75 mm, black, plastic, mechanical (changeover contact) with on/off switch and ventilation											1320416A
	Plug kit Replacement for 10-pin plug on standard wiring harness, with connection materials					■						9029701A
	Plug kit Replacement for 2-pin plug on the standard wiring harness, with connection materials					■						9029702A
	Plug kit Replacement for 4-pin plug on standard wiring harness, with connection materials, plug suitable for PC diagnosis					■		■				9029703A
	Extension cable control panel Standard/MC L = 1800 mm	■	■	■	■							1319724A



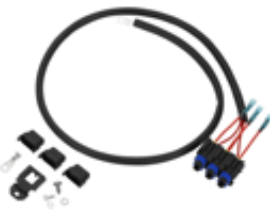

Electrical Accessories

		Thermo Top C/E	Air Top 2000 STC	Air Top Evo 40/55	Thermo Top Evo	Thermo Pro 50 Eco	Thermo Pro 90	DBW 2010/2016	Thermo Top Pro 120/150	Dual Top Evo	eThermo Top Eco 20 P/30 P	Order number
	Fastening base black, plastic, for fuse holders, 1320313A, 1320157A, 1320151A, with screws	■	■	■	■	■	■	■				1320873A
	Flat spring contact 0.5 ... 1.5, 2.8 mm, with seals and plugs, bag of 10 pieces	■	■	■		■	■	■				9011664A
	Flat spring contact For fuse holder, watertight, bag of 10 pieces											
	0.5 ... 1.5	■	■	■	■	■	■	■				9011645A
	2.0 ... 3.0	■	■	■	■	■	■	■				9011647A
	4.0 ... 6.0	■	■	■	■	■	■	■				9009029B
	Junior power timer 0.5 ... 1, also for blade-type plug, watertight, bag of 10 pieces	■	■	■	■	■	■	■				9011634B
	Micro Quadlok System socket contact 0.75, 2.8 mm, for 6-pin watertight plug sleeve casing, bag of 10 pieces	■	■	■		■	■	■				9011666A



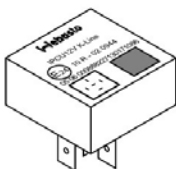

Electrical Accessories

		Thermo Top C/E	Air Top 2000 STC	Air Top Evo 40/55	Thermo Top Evo	Thermo Pro 50 Eco	Thermo Pro 90	DBW 2010/2016	Thermo Top Pro 120/150	Dual Top Evo	eThermo Top Eco 20 P/50 P	Order number
	Fuse holder											
	black, plastic, for flat fuses SAE J1284, watertight											
	1 A, for 1 A blade fuse, for 6.3 mm tab connector, with slot marking in black	■	■	■	■	■	■	■				1320313A
	5 A, for 5 A blade seal, for 6.3 mm tab connector, with slot marking in beige	■	■	■	■	■	■	■				1320157A
	20 A, for 20 A blade fuse, for 6.3 mm tab connector, with slot marking in yellow	■	■	■	■	■	■					1320151A
	Fuse holder kit											
	black, plastic, watertight, replaces triple fuse holder on heater wiring harness, contents: 3 1320313A fuse holders and mounting parts (without fuses and mounting bases)	■	■	■		■	■	■				1321809A
	Additional fuse kit											
	black, plastic, watertight, for flat fuses SAE J1284, watertight	■	■	■	■	■	■	■				1301682A
	Heat shrinkable hose											
	Di min = 19 mm, Di max = 38 mm, wall thickness 1 mm, shrinkage rate 2:1, operating temperature range -55 °C to +125 °C											
	L = 100 mm	■	■	■	■	■	■	■				1322452A
	L = 5000 mm	■	■	■	■	■	■	■				1321590A
	L = 50000 mm	■	■	■	■	■	■					1321589A
	IPCU (kit)											
	black, plastic case, with IPCU module, wiring harnesses and installation instructions, for PWM of vehicle blowers	■			■							9013645A

Electrical Accessories

		Thermo Top C/E	Air Top 2000 STC	Air Top Evo 40/55	Thermo Top Evo	Thermo Pro 50 Eco	Thermo Pro 90	DBW 2010/2016	Thermo Top Pro 120/150	Dual Top Evo	eThermo Top Eco 20 P/30 P	Order number
	IPCU module											
	black, plastic case, for PWM of vehicle blowers	■			■							1322640A
	Wiring harness adapter kit											
	for connection of old to new wiring harness									■		1320837A
	Plug kit											
	Replacement for 2-pin plug on the fuel pump wiring harness, with connection materials and assembly instructions, for fuel pump DP 42			■	■	■	■					1318966A
	Plug sleeve casing											
	For 6.3 mm receptacles, 1-pin, bag of 20 pieces	■	■	■	■	■	■	■				1320229A
	Plug sleeve casing											
	for fuel pump or extensions, watertight, bag of 5 pieces											9021277A

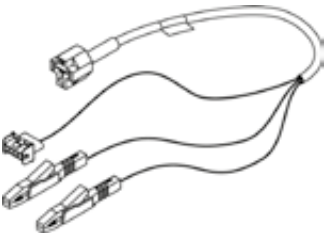



Electrical Accessories

		Thermo Top C/E	Air Top 2000 STC	Air Top Evo 40/55	Thermo Top Evo	Thermo Pro 50 Eco	Thermo Pro 90	DBW 2010/2016	Thermo Top Pro 120/150	Dual Top Evo	eThermo Top Eco 20 P/50 P	Order number
	Plug sleeve casing for 6.3 mm tab receptacles, 2-pin	■	■	■	■	■	■	■				1319698A
	Plug sleeve casing for 6.3 mm tab receptacles, 4-pin, bag of 10 pieces											1321698A
	Plug sleeve casing for 6.3 mm tab receptacles, 6-pin, bag of 10 pieces	■	■	■	■	■	■	■				1321670A
	Programming wiring harness	■				■	■					1319879B
	Relay (changeover contact) kit 12 V, black, plastic case, with connector housing and flat fuses	■	■	■	■							9023375A





Electrical Accessories

		Thermo Top C/E	Air Top 2000 STC	Air Top Evo 40/55	Thermo Top Evo	Thermo Pro 50 Eco	Thermo Pro 90	DBW 2010/2016	Thermo Top Pro 120/150	Dual Top Evo	eThermo Top Eco 20 P/30 P	Order number
	<p>Relay (changeover contact) with freewheeling diode</p> <p>24 V, Protection class IP67, with mounting tab for M5 screw</p>											1320214A
	<p>Relay (changeover contact)</p> <p>12 V, black, plastic case, protection class IP67, without mounting tab</p>	■	■	■	■							1320947A
	<p>Relay (changeover contact)</p> <p>12 V, grey, plastic case, with included mounting tab, freewheeling diode</p>	■	■	■	■							1319954A
	<p>Relay base</p> <p>without mounting tab, for standard relay</p>	■	■	■	■	■	■	■				1320538A
	<p>Relay base</p> <p>with mounting tab, for standard relay</p>	■	■	■	■	■	■	■				1320540A



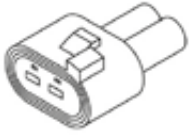

Electrical Accessories

		Thermo Top C/E	Air Top 2000 STC	Air Top Evo 40/55	Thermo Top Evo	Thermo Pro 50 Eco	Thermo Pro 90	DBW 2010/2016	Thermo Top Pro 120/150	Dual Top Evo	eThermo Top Eco 20 P/50 P	Order number
	Resistor kit W = 46 mm, H = 20 mm, 40 W, 0.9 Ω, with plugs and fastening parts	■			■							97981A
	Single-wire seal Da = 4.1 mm, L = 9 mm, green, 0.5 ... 0.75, bag of 20 pieces Da = 5.4 mm, L = 8 mm, white, 1.5 ... 2.5, bag of 10 pieces Da = 5.4 mm, L = 8 mm, light blue, 0.35 ... 1.00, bag of 20 pieces Da = 5.6 mm, L = 8 mm, red, for MTA-fuse holder, bag of 20 pieces	■	■	■	■	■	■					9011955A
		■	■	■	■	■	■					9011627A
		■	■	■	■	■	■					9011626A
		■	■	■	■	■	■					9011631A
	Tab connector 1 ... 2.5, 0.5 mm, for watertight plug connections, with seals and plugs, bag of 2 pieces	■	■	■		■	■	■				9011628A
	Plug sleeve casing 0.5 mm, 2-pin, watertight, bag of 5 pieces	■	■	■		■	■	■				9011632B
	Tab connector housing for 6.3 mm tab connector, 1-pin, bag of 20 pieces											9006460A

Electrical Accessories

		Thermo Top C/E	Air Top 2000 STC	Air Top Evo 40/55	Thermo Top Evo	Thermo Pro 50 Eco	Thermo Pro 90	DBW 2010/2016	Thermo Top Pro 120/150	Dual Top Evo	eThermo Top Eco 20 P/30 P	Order number
	Tab connector housing for 6.3 mm tab receptacles, 2-pin, bag of 20 pieces	■	■	■	■	■	■	■				1320230A
	Tab connector housing for 6.3 mm tab receptacles, 4-pin	■	■	■	■	■	■	■				1319699A
	Tab connector housing for 6.3 mm tab receptacles, 6-pin, bag of 20 pieces	■	■	■	■	■	■	■				1320231A
	Tab connector housing for 6.3 mm tab receptacles, 8-pin, bag of 10 pieces	■	■	■	■	■	■	■				1321669A
	Tab connector housing for standard wiring harness, 2-pin, watertight, with flat spring contacts and single-wire seals	■										9021719A





Electrical Accessories

	Thermo Top C/E	Air Top 2000 STC	Air Top Evo 40/55	Thermo Top Evo	Thermo Pro 50 Eco	Thermo Pro 90	DBW 2010/2016	Thermo Top Pro 120/150	Dual Top Evo	eThermo Top Eco 20 P/50 P	Order number
 <p>Repair kit for wiring harness with 2-pin and 6-pin socket housings, flat spring contacts and single-wire seals</p>	■				■						9011968A
 <p>Tab receptacle</p>											
6.3 mm, for cable cross section 0.5 - 1.0 mm ² , bag of 10 pieces	■	■	■	■	■	■	■				9011636A
6.3mm, for cable cross section 1.0 mm ² , bag of 10 pieces	■	■	■	■	■	■	■				9011652A
6.3mm, for cable cross section 2.5 mm ² , bag of 10 pieces	■	■	■	■	■	■	■				9011641A
6.3 mm, for cable cross section 2.5 mm ² , bag of 50 pieces	■	■	■	■	■	■	■				1320228A
 <p>Tab receptacle bag of 10 pieces</p>											
for cable cross section 0.8 - 2.5 mm ²	■	■	■	■	■	■	■				9011640A
for cable cross section 4.0 - 6.0 mm ²	■	■	■	■	■	■	■				9014955A
 <p>Temperature sensor Closes at 40 °C</p>	■				■	■	■				1322511A
 <p>Temperature sensor external L = 5000 mm</p>		■									1319842A

Electrical Accessories

	Thermo Top C/E	Air Top 2000 STC	Air Top Evo 40/55	Thermo Top Evo	Thermo Pro 50 Eco	Thermo Pro 90	DBW 2010/2016	Thermo Top Pro 120/150	Dual Top Evo	eThermo Top Eco 20 P/30 P	Order number
	Temperature sensor external										
	L = 2500 mm		■	■							9030881A
	L = 5000 mm		■								9030883A
	L = 5000 mm, with housing cover		■	■							93205A
	L = 20000 mm, with housing cover			■							92649B
	Temperature switch										
	Closes at 2 °C, for operating the parking heater as an auxiliary heater										1319804A
	Closes at 10 °C, for operating the parking heaters as an auxiliary heater										1321617A
	Closes at 12 °C, for operating the parking heaters as an auxiliary heater										9030618A
	Holder										
	For temperature switch, for mounting the temperature switch on the vehicle										1319805A
	Thermo Top C dummy plug										
	if coolant pump is omitted, with resistor	■									1319667A
	Wiring harness extension										
	for standard wiring harness	■				■					1319720A



Electrical Accessories

	Thermo Top C/E	Air Top 2000 STC	Air Top Evo 40/55	Thermo Top Evo	Thermo Pro 50 Eco	Thermo Pro 90	DBW 2010/2016	Thermo Top Pro 120/150	Dual Top Evo	eThermo Top Eco 20 P/50 P	Order number
 <p>Plug kit Replacement for 2- and 6-pin plugs on standard wiringharness, with connection materials</p>				■							1319023A
 <p>Y adapter for wiring harness for retrofitting ThermoCall with Telestart already fitted</p>						■		■			1319820A
 <p>Y adapter for wiring harness Telestart digital timer 1533 connection</p>	■										1319873A
 <p>Extension cable L = 1500 mm, 230 V, orange</p>									■		1325983A
 <p>Fixation for mounting cable</p>									■		1325987A



Electrical Accessories

	Thermo Top C/E	Air Top 2000 STC	Air Top Evo 40/55	Thermo Top Evo	Thermo Pro 50 Eco	Thermo Pro 90	DBW 2010/2016	Thermo Top Pro 120/150	Dual Top Evo	eThermo Top Eco 20 P/30 P	Order number	
	House connecting cable											
	230 V, black											
											■	1325978B
											■	1325980B
											■	1325981B
										■	1325985B	
	House connecting cable angled											
											■	1325979B
	Installation kit mounting cable complete											
											■	1325988A
	Mounting plate											
											■	1325974A
	Harness Blower Control											
											■	1325724A
for blower control eThermo Top Eco to Thermo Top Evo												

Electrical Accessories

		Thermo Top C/E	Air Top 2000 STC	Air Top Evo 40/55	Thermo Top Evo	Thermo Pro 50 Eco	Thermo Pro 90	DBW 2010/2016	Thermo Top Pro 120/150	Dual Top Evo	eThermo Top Eco 20 P/50 P	Order number
	Temperature switch L = 83.5 mm, copper alloy, opens at 0,5°C +/- 2,5°C, closes at 5,5°C +/- 2,5°C, M14 x 1.5 connection thread								■			9036519A
	Wiring harness L = 4500 mm, bushing housings 2 pol, 4 pol, 12 pol.								■			9034537A
	Wiring harness vehicle fan L = 1600 mm								■			1321993A
	Fuse holder L = 1000 mm								■			1321992A
	Bag electric with 5pol. relay and connectors								■			9024913A
									■			9024914A

Electrical Accessories

	Thermo Top C/E	Air Top 2000 STC	Air Top Evo 40/55	Thermo Top Evo	Thermo Pro 50 Eco	Thermo Pro 90	DBW 2010/2016	Thermo Top Pro 120/150	Dual Top Evo	eThermo Top Eco 20 P/30 P	Order number
 <p>Bag connector 12 pin Bushing housing 12 pol., cover cable exit 90°, 9 bushing contacts MCP 1.5K, 9 seals, 9 blind plugs</p>								■			9035426A
 <p>Bag connector 2 pin Bushing housing 2 pol., cover cable exit 90°, 2 bushing contacts MCP 6,3; 2 seals</p>								■			9035427A
 <p>Bag connector U4850 kit connectors for coolant pump U4850 and for Thermo Pro 120/150</p>								■			9035429A

Maintenance and Diagnostics

		Air Top 2000 STC	Air Top Evo 40/55	Thermo Top Evo	Thermo Pro 50 Eco	Thermo Top C/E	Thermo Pro 90	Dual Top Evo	Thermo Top Pro 120/150	Thermo 230/300/350	DBW 2010/2016	Thermo S 230/300/350/400	Order number
	Adapter cable, PC diagnosis also for upgrade kit (digital timer 1533 or Telestart)	■	■	■	■	■	■	■	■				1319503A
	Adapter cable, PC diagnosis					■							1319943A
	Adapter cable, PC diagnosis	■											1319940A
	Adapter cable, PC diagnosis								■				1320899A
	Adapter cable, PC diagnosis Thermo 230/300/350 (Van Hool)								■				1319945A

Maintenance and Diagnostics

	Air Top 2000 STC	Air Top Evo 40/55	Thermo Top Evo	Thermo Pro 50 Eco	Thermo Top C/E	Thermo Pro 90	Dual Top Evo	Thermo Top Pro 120/150	Thermo 230/300/350	DBW 2010/2016	Thermo S 230/300/350/400	Order number
 <p>Adapter cable, PC diagnosis Thermo 230/300/350 (Mercedes / Citaro)</p>									■			1319685A
 <p>Adapter cable, PC diagnosis</p>			■									1319941A
 <p>Adjusting tool for ignition electrodes</p>										■		1320998A
 <p>PC Diagnosis Kit USB and serial port, for Windows operating system</p>	■	■	■	■	■	■	■	■	■	■	■	1320920A

Webasto subsidiaries and representatives

Head Office

Webasto Thermo & Comfort SE

Friedrichshafener Straße 9
82205 Gilching
Tel.: +49 89 85794-0
www.webasto.com

Argentina

FRIBA TECNOLOGÍA S.A.

Av. Pavón 4080/84
C1253AAY Buenos Aires
Phone: +54 11 49242117
www.friba.com.ar

Australia

Webasto Thermo & Comfort

Australia Pty. Ltd.

423-427 The Boulevarde
NSW 2232 Kirrawee
Phone: +61 2 85364800
webasto.com.au

Austria

Webasto Fahrzeugtechnik G.m.b.H.

Jochen-Rindt-Straße 19
1230 Vienna
Phone: +43 1 6043780
www.webasto.at

Belarus

Falkat GmbH

Ul. Drozda 8
220004 Minsk
Phone: +375 17 2001894
www.falkat.com

Benelux

Webasto Thermo & Comfort

Benelux B.V.

Constructieweg 47
8263 BC Kampen
Phone: +31 38 3371137
www.webasto.nl

Brazil

Webasto Thermo & Comfort – LA-TAM

Av. Padre Manoel da Nóbrega,
355 – A31 – Campinas – SP
13061 – 140 – Brasil
Phone: +55 19 9 9504 5151
www.webasto.com/br

Bulgaria

Rhea MP GmbH

ul. Boris Iliev 17
1839 Sofia
Phone: +359 2 9420555
www.rheamp.com

Chile

Webasto Thermo & Comfort - LATAM

Hermanos Cabot 6707 - Dpt. 126
Las Condes – Santiago de Chile
7561255 – Chile
Phone: +56 (9) 4683 1100
www.webasto.es

China

Webasto Thermo & Comfort Technology (Beijing) Co. Ltd.

A 2105, Building 2,
Boya International Center
No. 1 Lize Zhongyi Road
Chaoyang District
100102 Beijing
Phone: +86 10 84782320
www.webasto.cn

Czech Republic

Webasto Thermo & Comfort Czech Republic s.r.o.

Na Strži 1373/35
14000 Praha 4
Phone: +420 241045450-7
www.webasto.cz

Denmark

Webasto Thermo & Comfort Denmark A/S

Islevdalvej 180
2610 Rødovre/Copenhagen
Phone: +45 44522000
www.webasto.dk

Estonia

AS KG KNUTSSON

Saeveski 12
11214 Tallinn
Phone: +372 6 519300
www.kgk.ee

Finland

Oy Kaha AB

Ansatie 2
01740 Vantaa
Phone: +358 9 61568379
www.kaha.fi

France

Webasto Thermo & Comfort France S.A.S.

PA Estuaire Sud
Rue du Camp d'Aviation
44320 Saint Viaud
Phone: +33 (0) 2 40 21 85 50
www.webasto-france.fr

Germany

Webasto Thermo & Comfort SE

Friedrichshafener Straße 9
82205 Gilching
Phone: +49 (0) 395 5592-229
www.webasto.de

Great Britain

Webasto Thermo & Comfort UK Ltd.

Webasto House
White Rose Way
Doncaster
South Yorkshire DN4 5JH
Phone: +44 (0) 1302 322232
www.webasto.co.uk

Webasto subsidiaries and representatives

Greece

SYSTEMS S.A.

73rd, Agias Annis street
18233 Rentis
Phone: +30 210 3472105
www.systemssa.gr

Hungary

Webasto Thermo & Comfort

Hungária Kft.

Szent László út 73
1135 Budapest
Phone: +36 1 3502338
www.webasto.hu

Iceland

Bilasmidurinn hf.

Bíldshofda 16
110 Reykjavík
Phone: +354 5672330
www.bilasmidurinn.is

India

Webasto Roofsystems

India Pvt. Ltd.

Ghat 838/1, Pune Nagar Highway
District: Sanaswadi
412208 Pune
Phone: +91 2137619902
www.webasto.com

Italy

Webasto Thermo & Comfort

Italy S.r.L.

Via Efreml Nobili 2
40062 Molinella (BO)
Phone: +39 051 6906 111
www.webasto.it

Japan

Webasto Thermo & Comfort

Japan Co. Ltd.

3-19-5 Shin-Yokohama Kohoku-ku
Kanagawa Prefecture
222-0033 Yokohama
Phone: +81 45 4741761
www.webasto.co.jp

Kazakhstan

Webasto Thermo & Comfort

Kazakhstan LLP

Alash High Road office No. 101, 22
010000 Astana city
Phone: +7 383 3637115
www.webasto.ru

Latvia

KG Knutsson SIA

Gunara Astras iela 3
1084 Riga
Phone: +371 67 807 870
www.webasto.lv

Lithuania

UAB KG Knutsson

Jocioniu g. 14
02300 Vilnius
Phone: +370 2758181
www.kgk.lt

Moldavia – via Webasto Romania

Webasto Romania Trading S.R.L.

Sos Odai, nr.40
075100 Otopeni, Ilfov
Phone: +40 21 2032751
www.webasto.ro

Mongolia - via Webasto China

Webasto Thermo & Comfort

Technology (Beijing) Co. Ltd.

A 2105, Building 2, Boya International
Center
No. 1 Lize Zhongyi Road
Chaoyang District
100102 Beijing
Phone: +86 10 84782320
www.webasto.cn

Netherlands

Webasto Thermo & Comfort

Benelux B.V.

Constructieweg 47
8263 BC Kampen
Phone: +31 38 3371137
www.webasto.nl

Norway

Webasto Thermo & Comfort

Norway

Industriveien 34A
2072 Dal
Phone: +47 61162000
www.webasto.no

Poland

Webasto Petemar Sp. z.o.o.

ul. Warszawska 205/219
05-092 Lomianki
Phone: +48 22 7327320
www.webasto.pl

Romania

Webasto Romania Trading S.R.L.

Sos Odai, nr.40
075100 Otopeni, Ilfov
Phone: +40 21 2032751
www.webasto.ro

Russia

Webasto Rus OOO

Ul. Gorki Kiovskie, vl. 13
141730 Lobnya
Moscow Region
Phone: +7 495 5796020
www.webasto.ru

Slovakia

Webasto Thermo & Comfort

Slovakia s.r.o.

Galgovecká ulica 3
040 11 Košice
Phone: +421 5 57871000
www.webasto.sk

Slovenia

Webasto Thermo & Comfort **avtomobilaska tehnika d.o.o.**

Cesta v Gorice 34
1000 Ljubljana
Phone: +386 1 2008712
www.webasto.si

Webasto subsidiaries and representatives

South Korea

Webasto Korea Inc.

Ideogwon IT Valley,
40 Imi-ro, Bldg. B, Suite 612
16006 Uiwang-si, Gyeonggi-do
Phone: +82 31 80170241
www.webasto.kr

Spain

Webasto Thermo & Comfort Ibérica S.L.U.

C/Mar Tirreno 33
Poligono Industrial
28830 San Fernando de Henares
(Madrid)
Phone: +34 91 626 86 11
www.webasto.es

Sweden

KG Knutsson AB

Hammarbacken 8
19181 Sollentuna. Stockholm
Phone: +46 8 923000
www.kgk.se

Switzerland

Lorch AG

Kriesbachstrasse 4
8600 Dübendorf
Phone: +41 (0) 44 299 98 98
www.webasto.ch

Turkey

Webasto Thermo Comfort İklimlendirme Sistemleri Ticaret Limited Sirketi

Manisa Organize Sanayi Boelgesi 4.
Kısım
Ahmet Nazif Zorlu Bulvarı No: 8
45030 Merkez / Manisa
Phone: +90 236 226 90 00
www.webasto.com.tr

USA

Webasto Thermo & Comfort North America Inc.

15083 North Road
48430 Fenton. Michigan
Phone: +1 810 5936100
www.webasto.us

Ukraine

Webasto Thermo & Comfort Ukraine LLC

Chervonopraporna str. 28
03045 Kiev
Phone: +380 (044) 503 31 76
www.webasto.com/ua



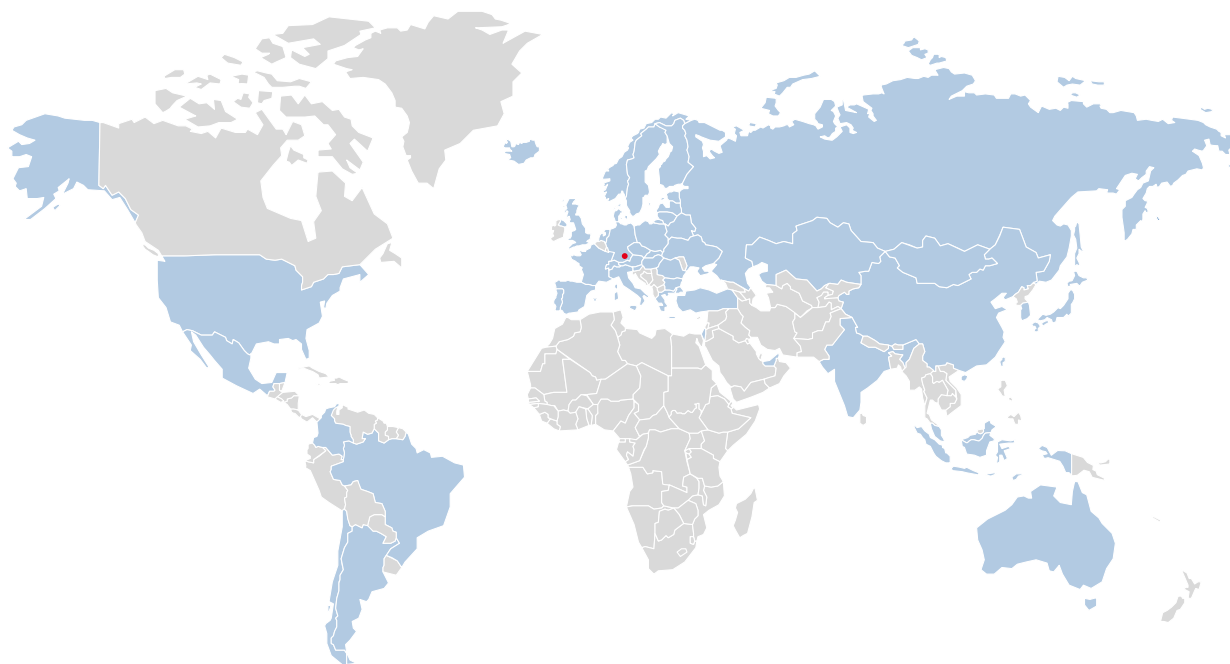

Since its foundation in 1901 the Webasto group has continued to set new technological standards in the original equipment and aftermarket sector. Today, we are one of the 100 biggest suppliers in the automotive industry worldwide. We develop and produce roof, convertible as well as heating, cooling and ventilation systems. Our products help provide a better atmosphere on the road, more comfort and security, as well as increased efficiency for cars, commercial and special vehicles, motor homes and boats. An outstanding network of production facilities and dealers guarantees high-quality products, installation standards and services worldwide.

